



We invite you to contact us for further details. All rights reserved.

The CENTURION and CENTSYS logos, all product and brand names in this document that are accompanied by the TM symbol are trademarks of Centurion Systems (Pty) Ltd, in South Africa and other territories; all rights reserved. All product and brand names in this document that are accompanied by the ® symbol are registered trademarks in South Africa and/or other countries, in favour of Centurion Systems (Pty) Ltd, South Africa.

EOE Centurion Systems (Pty) Ltd reserves the right to change any product without prior notice.

After Hours International Technical Support Call Centre  
+27 11 699 2481 (16:00 to 02:00 - Australian Eastern Time)

Call: 1300 CENTSYS (1300 236 879)

www.centsys.com.au

from 07h00 to 18h00 (UTC+2)

Call Technical Support: +27 11 699 2481

Head Office: +27 11 699 2400

Call Centurion Systems (Pty) Ltd - South Africa

Subscribe to the newsletter:  
www.centsys.com/subscribe

centurion.systems

@askcenturion

YouTube.com/centurionsystems

facebook.com/centurionsystems

Connect with us on:

www.centsys.com



## SLIDING GATE OPERATORS

# D10 SMART / D10 TURBO SMART / D20 SMART QUICK GUIDE



D10 SMART

D10 TURBO SMART

D20 SMART

## 1. Introduction

This guide is designed specifically for installers who are familiar with the installation of standard sliding gate operators, but do not know the specifics of the **D10 SMART / D10 Turbo SMART / D20 SMART**.

## 2. Important Safety Instructions



Please refer to the full installation manual in the MyCENTSYS Pro mobile application for the full safety instructions. Follow the instructions under Section 13 of this Quick Guide to download the MyCENTSYS Pro mobile application.

Please do not proceed with the installation until you have read and fully understand the Safety Instructions.

## 3. Icons used in this manual



This icon denotes variations and other aspects that should be considered during installation.



This icon indicates tips and other information that could be useful during the installation.



This icon indicates warning, caution or attention! Please take special note of critical aspects that MUST be adhered to in order to prevent injury.

## 4. General Description

The **D10 SMART** is a heavy duty sliding gate operator designed to open and close industrial sliding gates weighing up to 1000Kg.

The **D10 Turbo SMART** is perfectly suited for sites with lighter gates requiring a high number of operations per day, and can reach almost double the speed of the standard **D10 SMART** for increased security. However, it is not suitable for gates weighing more than 250kg, as the inertia generated by heavier loads might prove detrimental to the gearbox at such high speeds. Refer to Table 2 under Section 6. - "Technical Specifications" for derating speeds on heavier gates.

A die-cast aluminium gearbox, coupled to a powerful 24V DC motor and switch-mode charger, makes the **D10 SMART / D10 Turbo SMART** the automatic choice for townhouse complexes and office parks.

The system operates off two 12V / 7.2 - 8Ah batteries housed inside the operator using a switch-mode charger to maintain the battery in a fully-charged state. The batteries provide critical power failure protection.

A non-contact Hall Effect Sensor ensures reliability and positional accuracy. The Hall Effect Sensor is highly resistant to dust, oil, dirt and insect ingress, thereby ensuring that the **D10 SMART / D10 Turbo SMART** opens and closes gates reliably and accurately.

For industrial sites with large, heavy gates and high traffic volumes, the **D20 SMART** offers a powerful and reliable automation solution that can move gates weighing up to 2000kg.

This formidable operator has been designed to withstand the most demanding operating conditions and work dependably in any environment thanks to its rugged die-cast aluminium gearbox and potent DC motor. In addition, its sophisticated electronics and motor control circuitry ensure that it moves smoothly with pinpoint stopping, further adding to the unit's reliability and longevity. Complementing its tough mechanical build, award-winning SMART technology makes the **D20 SMART** as intelligent as it is solid.

## 5. Product Identification

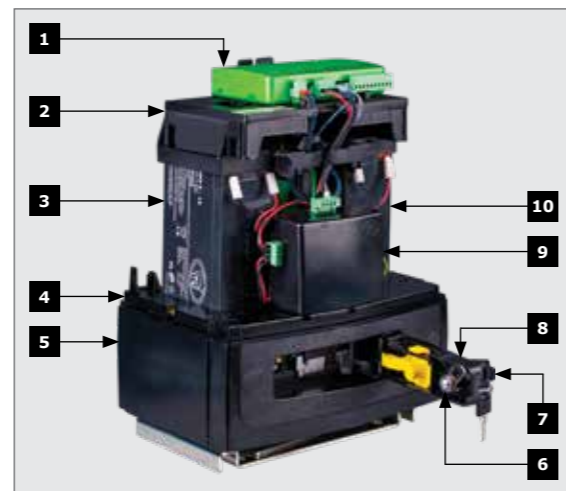

FIGURE 1

- |                                   |                                    |
|-----------------------------------|------------------------------------|
| 1. DX Control Card                | 6. Camlock                         |
| 2. Accessory Tray                 | 7. Camlock Cover                   |
| 3. 12V 7.2Ah Battery <sup>4</sup> | 8. Release Handle                  |
| 4. Lower Battery Tray             | 9. Switch-mode Charger 27.4V 1.8A  |
| 5. Gearbox Trim                   | 10. 12V 7.2Ah Battery <sup>1</sup> |

1. Batteries are not supplied with the D10 SMART / D10 Turbo SMART / D20 SMART.

## 6. Technical Specifications

	D10 SMART	D10 Turbo SMART	D20 SMART
Input voltage	90V - 240V AC +/-10% @ 50Hz <sup>1</sup>		
Maximum number of operations per day	750 <sup>2,5</sup>		
Motor power supply	Battery-driven (Standard Capacity - 2x 12V 7.2Ah)		
Current consumption (motor at rated load)	8A	10A	9A
Motor push force - starting	40kgf	24kgf	52kgf
Motor push force - rated	30kgf	18kgf	39kgf
Gate mass - maximum	1000kg	250kg <sup>6</sup>	2000kg
Gate length - maximum	50m	50m	25m
Gate speed (varies with load)	Up to 26m/min <sup>3</sup>	Up to 45m/min <sup>6</sup>	Up to 18m/min <sup>3</sup>
<b>Operating Mode</b>			
Operations in standby (7.2Ah Batteries)	Power saving 15m/min 15kgf	Normal 26m/min 15kgf	Power saving 15m/min 15kgf
	Normal 15m/min 15kgf	Normal 45m/min 9kgf	Normal 18m/min 20kgf
Half day <sup>2,4,5</sup>	118	63	189
Full day <sup>2,4,5</sup>	93	50	150
	104	80	45

TABLE 1

- Can operate off a solar supply; consult your local dealer for assistance
- Based on a motor push force of less than 50% of rated (Starting and Running forces)
- Gate opening and closing speeds can be configured to run slower depending on the requirements of individual installations
- Can increase battery capacity for longer standby times
- Based on 4m gate, excluding all accessories
- Refer to Table 2 under Section 6. - "Technical Specifications" for derating speeds on heavier gates

### RECOMMENDED SPEED AND GATE MASSES FOR D10 TURBO SMART<sup>1</sup>

Max Speed (m/min)	Gate Mass (Kg)
45	250
41	300
36	400
32	500
29	600 <sup>2</sup>
27	700 <sup>2</sup>
25	800 <sup>2</sup>
24	900 <sup>2</sup>
23	1000 <sup>2</sup>

TABLE 2

- If a **D10 Turbo SMART** is used on a gate over 250Kg, the speed must be reduced according to the table above to ensure that the gate can be safely stopped in an emergency.
- Centurion Systems (Pty) Ltd recommends the use of a **D10 SMART** for gates weighing over 500Kg.

## 7. Preparation of Site

Always recommend the fitment of additional safety equipment such as safety edges and safety beams, for additional protection against entrapment or other mechanical risks.

Check that no pipes or electrical cables are in the way of the intended installation.

Check that enough space is available for the gate operator, specifically for the release handle and the removal of the Gearbox Trim

Check for loose, sandy soil if installing a foundation, as the soil condition may require a larger foundation.

Never fit the operator on the outside of the gate, where the public has access to it.

### Install the gate operator only if:

- It will not pose a hazard to the public
- There is sufficient clearance to a roadway and/or public thoroughfares
- The installation meets all municipal and/or local authority requirements once completed
- The gate mass and application are within the operator specifications
- The gate is in good working order, meaning:
  - it opens freely;
  - it does not move on its own if left in any position;
  - it can be installed to have sufficient clearance between moving parts when opening and closing to reduce the risk of personal injury and entrapment
- Pushbuttons or key-switches, when required, must be positioned so that the gate is in line-of-sight of the user

### Starting and Running Forces

Test the starting force of the gate to ensure that the gate is within the operator specifications as per Figure 2. Use a pull scale in both directions to determine the maximum amount of pull force required to set the gate in motion.

Determine the running force of the gate by continuing to pull on the scale with just sufficient force to keep it running. Read and note the maximum value in kgf (kilogram-force) shown on the scale.

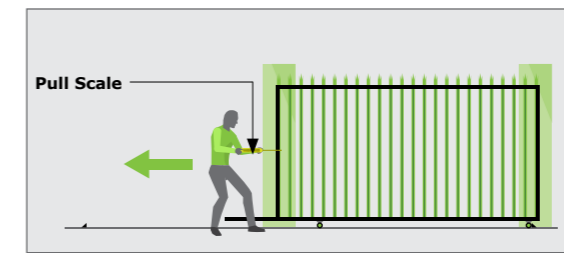

FIGURE 2

### Typical anti-lift arrangements

Guide-rollers must ensure that the gate is held vertically through the entire length of the gate travel. For improved safety, fit additional support posts to prevent gate from falling over if guide-rollers fail.



Ensure that the gate cannot be lifted off the motor pinion with the anti-lift bracket fitted.

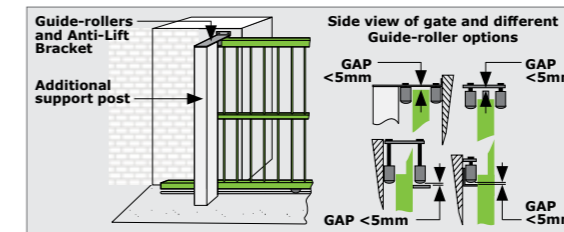

FIGURE 3

### Endstops

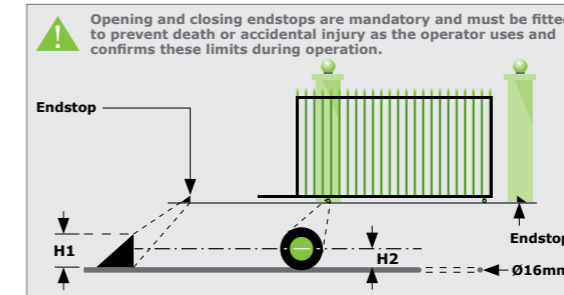

FIGURE 4

## 8. Cabling Requirements

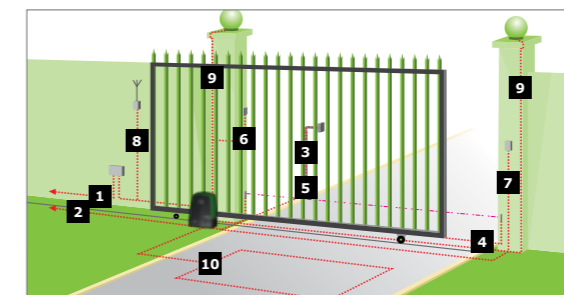

FIGURE 5

### Legend

- MAINS SUPPLY CABLE:** 90V - 240V AC mains cable via double-pole mains isolator-switch (3 core L.N.E. 1.5mm<sup>2</sup> SWA)<sup>1,2</sup>
- Optional **intercom** cable from motor to dwelling (n1 + 6 core<sup>3</sup> 0.22mm<sup>2</sup> multi-strand shielded cable)
- Optional **intercom** cable from motor to entry panel (n2 0.22mm<sup>2</sup> multi-strand shielded cable)
- Optional but recommended **infrared safety beams** (3 core 0.22mm<sup>2</sup> multi-stranded)<sup>4</sup>
- Optional **access control device** (3 core 0.22mm<sup>2</sup> multi-stranded)
- Optional **pedestrian key-switch** (2 core 0.22mm<sup>2</sup> multi-stranded) OR
- Optional **keypad** (3 core 0.22mm<sup>2</sup> multi-stranded)<sup>4</sup>
- Optional **external radio receiver** (3 core 0.22mm<sup>2</sup> multi-stranded)<sup>5</sup>
- Optional **pillar lights** (3 core LNE SWA, size according to power requirements)<sup>6</sup>
- Optional **ground loop for free-exit** (1 core 0.5mm<sup>2</sup> multi-stranded - silicone coated)<sup>7</sup>

n1 means the number of cores required by an intercom

n2 means the number of cores required by an intercom

1. Possibly increase cable thickness if pillar lights are installed.

2. Type of cable must adhere to municipal bylaws but typically SWA (steel wire armoured) cable is recommended. The armouring provides excellent screening, which gives better protection against lightning - earth one end of the screening.

3. Allows for all features such as pedestrian opening, status LED, etc., to be operated from the intercom handset inside the dwelling. Number of cores and type of cable could vary depending on brand of access control system being used.

4. Wireless accessories are available. Please refer to www.centsys.com for further information.

5. For optimum range, an external receiver can be mounted on the wall.

6. Requires an external relay

7. Consult manufacturer of loop detector for specific details.

## 9. Manual Override



Before mounting the rack to the gate, ensure that the **D10 SMART / D10 Turbo SMART / D20 SMART** is in Manual Override. Follow the instructions below.

To disengage (Manual Override) the motor, ensure that the Camlock is in the "unlocked" position, and pull the Release Handle to a 90° position. The Motor will then be placed in a temporary state of disengagement.

### Manual Override Latching

In the event of a power failure, it may be required to lock the cover in place whilst "latching" the manual release (i.e. manual release permanently enabled). This helps prevent theft of the unit, or its components, and provides full protection from the elements.

With the release handle in the open position, slide the Override Cam located on the inside of the handle towards the gearbox, and a "click" can be heard once it has located correctly.

Return the handle to the closed, or locked, position. This allows continued manual operation of the gate while ensuring that the cover remains securely locked in place. See Figure 7.

To re-engage the **D10 SMART / D10 Turbo SMART / D20 SMART** (i.e. take the operator out of latched Manual Override), push the Release Handle Override Cam to the right and then slide it towards the Camlock. See Figure 8.

To re-engage the **D10 SMART / D10 Turbo SMART / D20 SMART** (i.e. take the operator out of latched Manual Override), push the Release Handle Override Cam to the right and then slide it towards the Camlock. See Figure 8.

## 10. Installation Preparation

To ensure that the operator does not protrude into the driveway, install the base plate at least flush with the driveway entrance.

It is typical to mount the rack above or underneath the pinion as shown in illustrations below.

The measurements given below are based on the rack supplied by Centurion Systems (Pty) Ltd, and are to be used as guidelines only.



Ensure that all the standard considerations for a quality gate installation are adhered to as detailed in our detailed installation manual.

### D10 SMART - Steel Rack

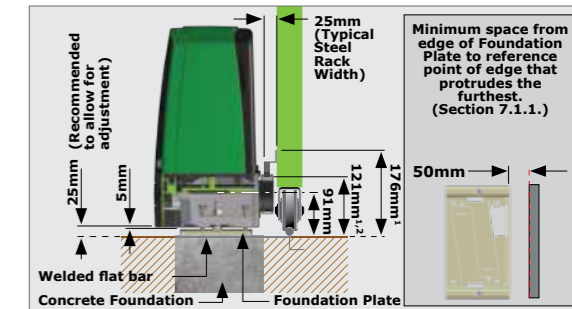

FIGURE 9

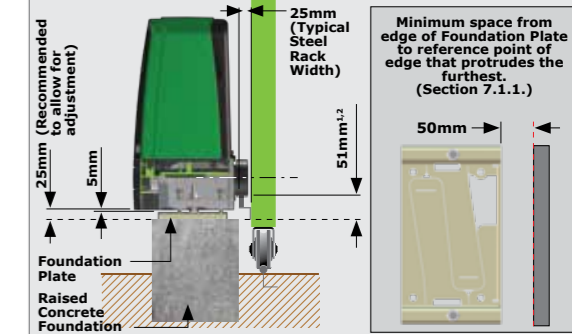

FIGURE 9

- Includes 3mm clearance required between rack and pinion
- Distance between bottom of the Foundation Plate and bottom edge of the Rack Tooth

The principles of installation on a Steel Rack is to position it in the middle of the output pinion with the operator fully forward on the slots.

The Pinion Guard needs to be rotated 180 degrees if the rack below the pinion is desired for **ONLY** the **D10 SMART** and **D20 SMART**, and not the **D10 Turbo SMART**.





## D10 Turbo SMART - Steel Rack

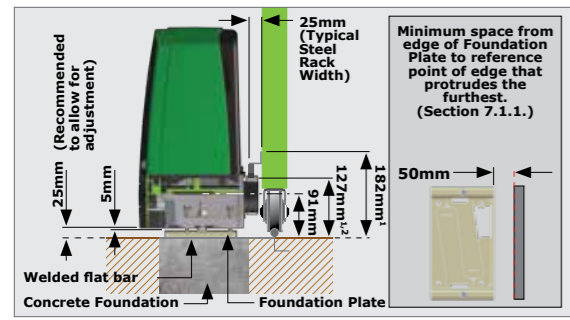

FIGURE 10

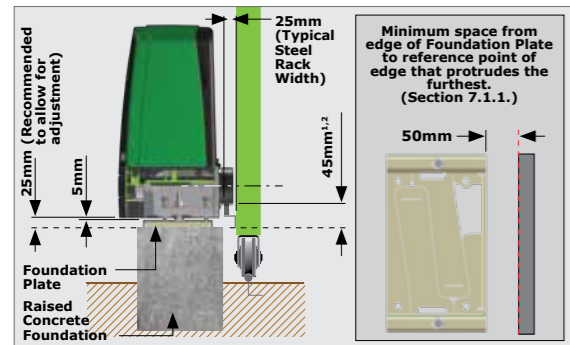

FIGURE 11

- Includes 3mm clearance required between rack and pinion
- Distance between bottom of the Foundation Plate and bottom edge of the Rack Tooth

The principles of installation on a Steel Rack is to position it in the middle of the output pinion with the operator fully forward on the slots.

## D20 SMART - Steel Rack

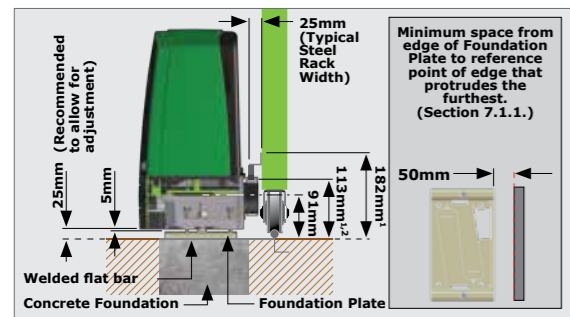

FIGURE 12

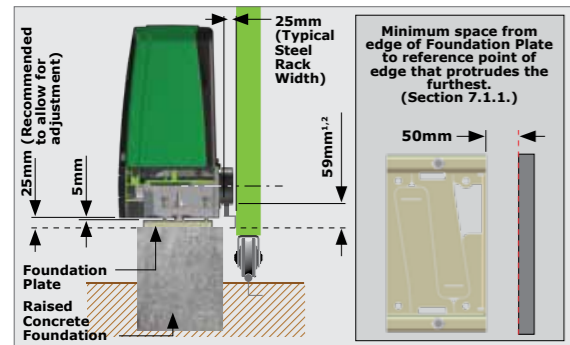

FIGURE 13

- Includes 3mm clearance required between rack and pinion
- Distance between bottom of the Foundation Plate and bottom edge of the Rack Tooth

The principles of installation on a Steel Rack is to position it in the middle of the output pinion with the operator fully forward on the slots.

The Pinion Guard needs to be rotated 180 degrees if the rack below the pinion is desired for **ONLY** the D10 SMART and D20 SMART, and not the D10 Turbo SMART.

### 10.1 Foundation plate installation

The foundation plate can either be set into a concrete foundation or bolted down onto an existing or new concrete plinth.

Check that the M10 half-nuts are tightened to 20Nm on the mounting bolts.

- Using a pair of pliers, gently bend the two tabs of the foundation plate down to a 90° angle.
- Again, using a pair of pliers, gently bend the two legs on each tab to an angle of 90° in opposite directions.

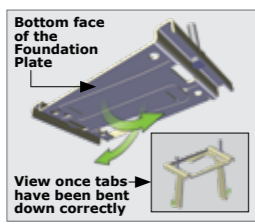

FIGURE 14

Lay the cabling conduit so that it routes the cables to the back of the Foundation Plate. Ensure that 30mm of conduit protrudes above the concrete.

Using medium-strength concrete (25MPa), cast the plinth according to the dimensions as shown in Figure 13.

When using a concrete foundation, it is recommended that the Foundation Plate is welded to the rail/track of the gate using a short length of flat bar, as shown in Figure 14. This makes it possible to complete the whole mechanical and electrical installation without having to wait for the concrete to set. After completing the installation, the concrete can be poured and the operator left in Manual Mode until the concrete has set. Do not operate the motor until the concrete has completely set.

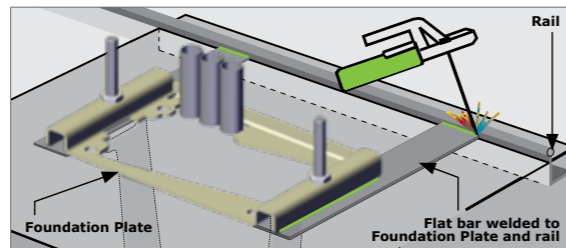

FIGURE 15

### 10.2 Existing concrete plinth

If bolting onto an existing concrete plinth, place the Foundation Plate down in the correct position and use the plate as a template for marking the Expansion Stud holes.

Check that the M10 half-nuts are tightened to 20Nm on the mounting bolts.

Ensure that the Expansion Studs do not protrude more than 23mm above the Foundation Plate.

Rerouting of existing cables may be necessary.

### 10.3 Conduit and Cable Length

Route the cables as determined in Section 8 - "Cabling Requirements". Make sure that the conduits protrude above the concrete foundation. The mains cables should protrude 450mm above the concrete foundation, and all signal cables (i.e. beams, etc.) 600mm above the concrete foundation, as shown in Figure 16.

## 11. Preparing the Operator for Installation

Open the Camlock Cover, and insert the Operator Key into the Camlock. Unlock it by turning the key anti-clockwise.

There is no need to open the Release Handle to remove the cover of the D10 SMART / D10 Turbo SMART / D20 SMART.

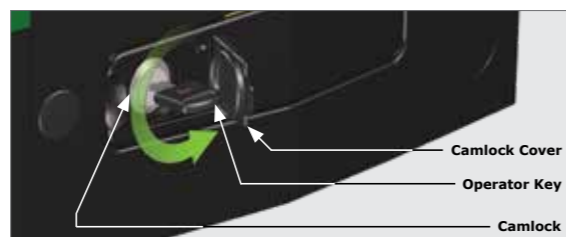

FIGURE 16

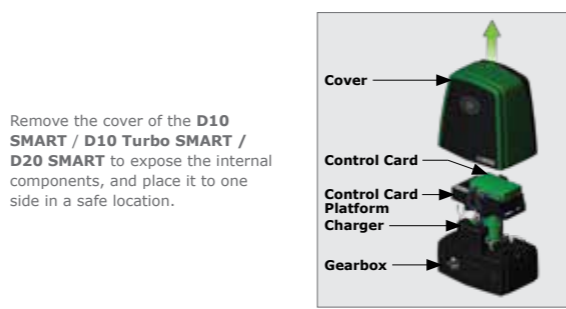

FIGURE 17

Remove the cover of the D10 SMART / D10 Turbo SMART / D20 SMART to expose the internal components, and place it to one side in a safe location.

### 11.1 Removing the Charger

Disconnect the Charger from the D10 SMART / D10 Turbo SMART / D20 SMART Control Card at either Point "A" or Point "B".

If the disconnection is made at Point "A", note that there are two connector blocks that need to be disconnected from the Control Card.

Disconnect the Earth Harness from the Charger at Point "C", and store it in a safe place.

Remove the Charger from the lower battery tray by gently pushing the Charger slightly down whilst pulling it towards the front of the D10 SMART / D10 Turbo SMART / D20 SMART. It should slide forward and off with ease.

## 12. Operator Installation

### 12.1. Mounting the Gearbox

To remove the Gearbox Trim with the battery tray, firstly ensure that the Camlock is in the "unlocked" position. Open the Manual Override Lever so that it is in the 90° position. Remove the Camlock Key, and keep it in a safe place. Hold the gearbox trim on both sides firmly and pull the entire assembly forward with a slight tug towards the front of the D10 SMART / D10 Turbo SMART / D20 SMART. It will unclip from the rear of the gearbox. Manoeuvre it over the Manual Override Lever to remove it completely off the gearbox.

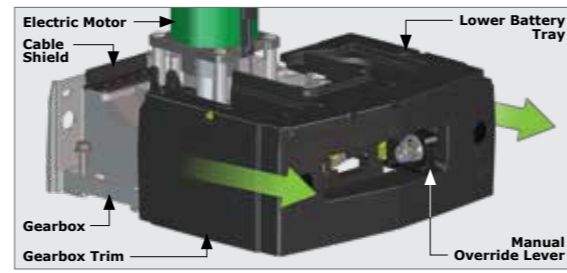

FIGURE 18

The Cable Shield needs to be removed before mounting the D10 SMART / D10 Turbo SMART / D20 SMART onto its Foundation Plate. This is done by lifting the Cable Shield up and away from the gearbox.

Once the Cable Shield has been removed, place the D10 SMART / D10 Turbo SMART / D20 SMART into position over the two Mounting Bolts, aligning them with the two slots at the bottom of the gearbox and rest the D10 SMART / D10 Turbo SMART / D20 SMART onto the Foundation Plate.

Once the Gearbox is resting on top of the Foundation Plate, slide the D10 SMART / D10 Turbo SMART / D20 SMART as far as possible towards the gate to allow for later adjustment.

Route cables as determined in Section 8 - "Cabling Requirements". POINT A is the entry point for cables with the conduit installed at the back of the unit as shown in Figure 25.

### 12.2. Routing the Cables

Route cables as determined in Section 8 - "Cabling Requirements". POINT A is the entry point for cables with the conduit installed at the back of the unit as shown in Figure 25.

### 12.3. Height Adjustment

The D10 SMART / D10 Turbo SMART / D20 SMART's unique Height Adjustment System adjusts from the top of the gearbox. This adds further security to the system, as it is not possible to access the Height Adjustment Bolts from the outside of the gearbox.

Using a ratchet and a 12mm socket, turn the Height Adjustment Bolt clockwise to lift the Operator, or turn it anti-clockwise, to lower the Operator.

### 12.4. Mounting the Rack

The rack must be securely mounted to the side of the gate. It must be parallel with the gate rail and there must be a 2-3mm gap between the rack teeth and the teeth of the pinion.

The D10 SMART is supplied with the Pinion Spyder, which greatly enhances the accuracy and speed of achieving the 2-3mm gap between the pinion and the gate's rack.

- Ensure that the D10 SMART Gearbox is in Manual Override.
- Start with the gate either fully open or fully closed.
- Slide the D10 SMART back towards the gate where the Pinion will sit just under where the rack will be fixed to the gate.
- Rest the rack directly onto the Pinion Spyder while welding / bolting the rack into position.
- Level the other end and fix that end to the side of the gate.

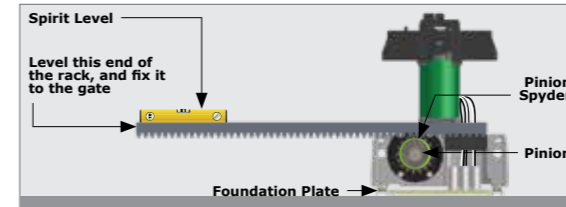

FIGURE 19

Before fully fixing each section of rack, slide the gate backwards and forwards along the section, checking that the rack is only resting on the Pinion Spyder, and not pressing down onto it.

### 12.5. Fitting Steel Rack to the Gate

Fix the Steel Rack with the steel angle brackets. The brackets must be spaced no more than 300mm apart.

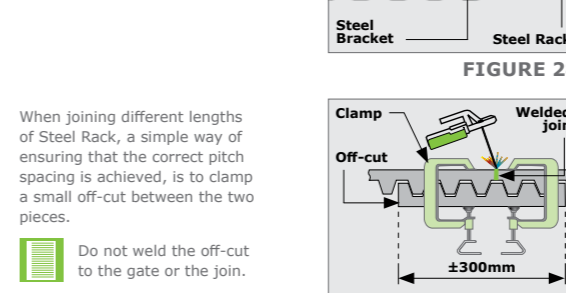

FIGURE 20

When joining different lengths of Steel Rack, a simple way of ensuring that the correct pitch spacing is achieved, is to clamp a small off-cut between the two pieces.

Do not weld the off-cut to the gate or the join.

Do not weld the off-cut to the gate or the join.



FIGURE 21

Route the Harness around the electric motor to the front of the operator, and through the cable retainers found in front of the Control Card.

Connect the Harness to the white "Origin" Terminal found on the Control Card.

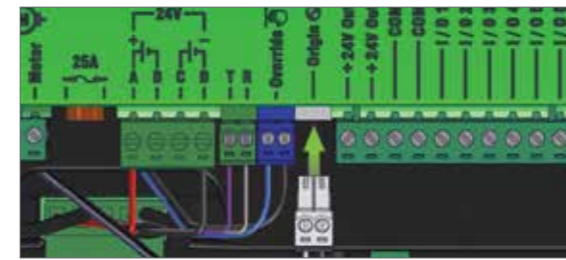

FIGURE 22

### Mounting the Origin Marker

Firstly, fully close the gate. Mount the Origin Marker to the rack a minimum of 500mm from the origin sensor.

It is possible to make the distance between the marker and the sensor much greater than 500mm. However, if using the pedestrian opening facility, although the position of the marker will not affect the width of the pedestrian opening, it is preferable to have the marker mounted inside of the pedestrian opening point.

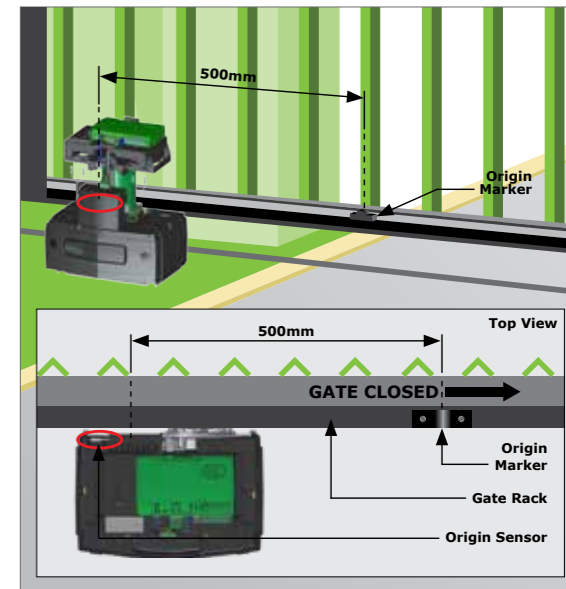

FIGURE 23

Note the orientation of the Origin Marker.

Manually slide the gate open until the origin marker is in line with the origin sensor.

Ensure the distance between the face of the marker and front face of the sensor is between 10 and 20mm.

Adjust distance by sliding the Origin Marker along the slotted mounting holes until the specified distance is achieved.

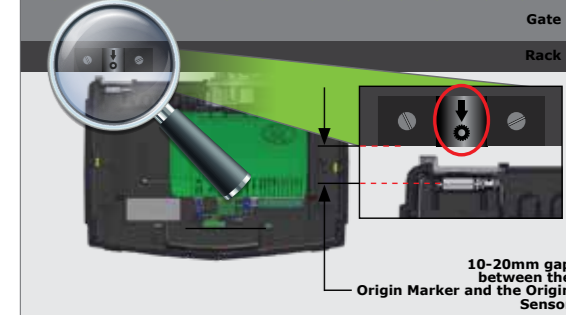

FIGURE 24

## 13. Commissioning the System

- Scan the QR Code in Figure 35.
- Select the App Store applicable to the operating system being used, either either Apple App Store, Android Google Play Store or the Huawei App Gallery.
- Download and install the application.

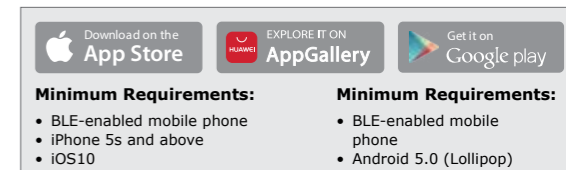

FIGURE 25

Alternatively, go directly to the app store of the operating system being used, and search for the app "MyCentsys Pro". Download and install the application onto the smartphone.

- Once installed, open the application.
- From the list of operators, select the operator that is applicable to this installation.
- Connect to the relevant operator.
- Use the app by following the prompts to configure the D10 SMART / D10 Turbo SMART / D20 SMART.

FIGURE 26