

Grandview

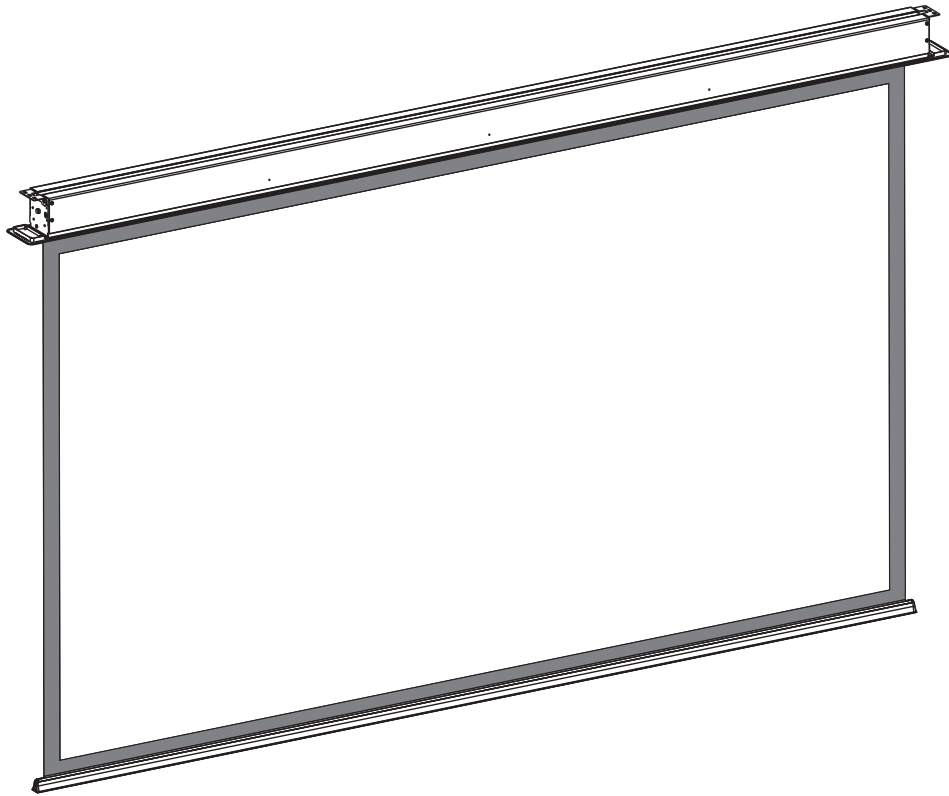

All in one Recessed Motorised Screen (IP Control) Installation Manual

MODEL:

GRIPRC92H GRIPRC102H GRIPRC112H GRIPRC120H GRIPRC130H
GRIPRC94C GRIPRC103C GRIPRC110C GRIPRC120C GRIPRC130C

Accessories Pack(s)

- Left Decoration cap*1 pcs (with control panel)

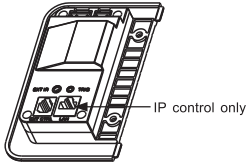

- Right Decoration cap*1 pcs

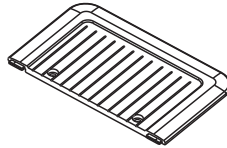

- M5*10 Cup head machine screw with cover (4 pcs respectively)



- Ceiling bracket*2 pcs

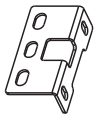

- M5*10 thumb head screw*4 pcs



- M4 hexagonal adjuster key*1 pc



- IR remote control emitter*1 pc

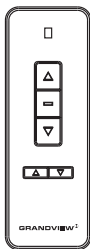

- Power cable with plug* 1 pc

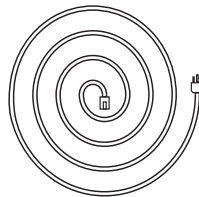

- Qualification certificate*1 copy

- Manual*1 set

- Warranty card* 1 set

Optional Accessories

- M8*500 extended bolt*2 pcs



- M8 nut*8 pcs, gasket*8 pcs



- Φ8 Spring gasket*6 pcs



- M8*60 expansion screw(4 pcs)

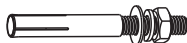

- Hook*2pcs

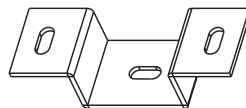

- EXT IR receiver*1 pcs



- Wall switch*1 pcs (low voltage dry contact control)



- 12V trigger wire*1 pcs



- RF power-sync emitter and RF converted to IR receiver*1 set

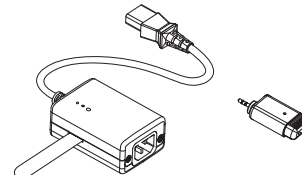

Operation Instruction

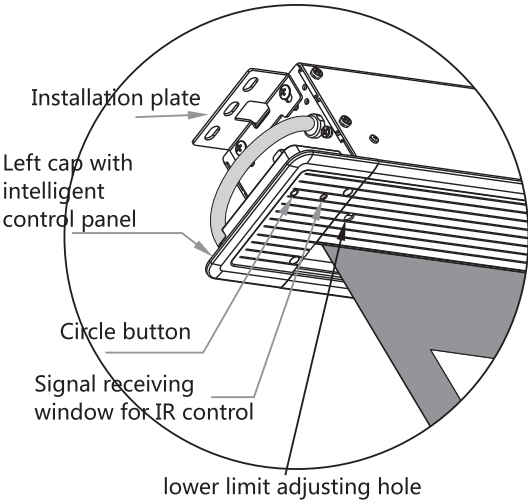
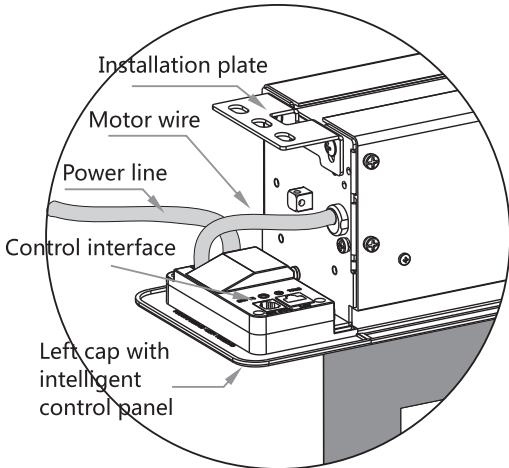
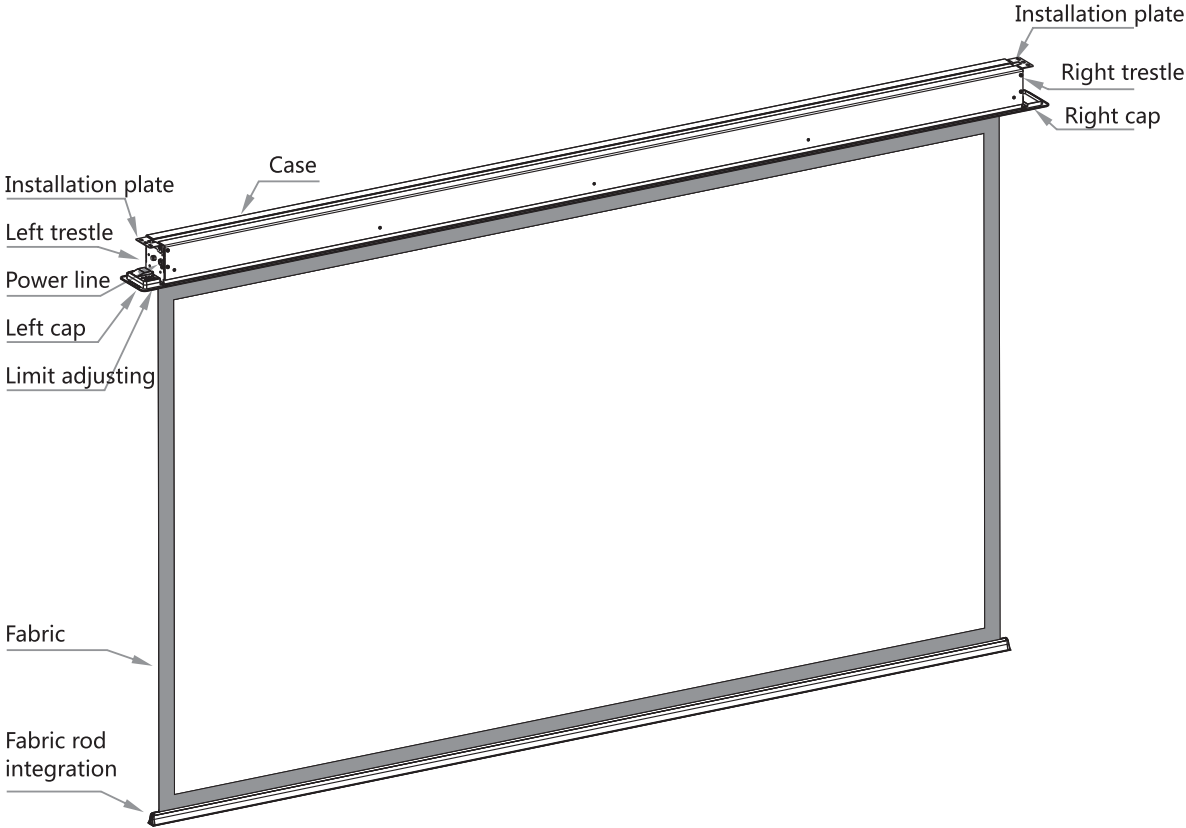

Framework and Dimension

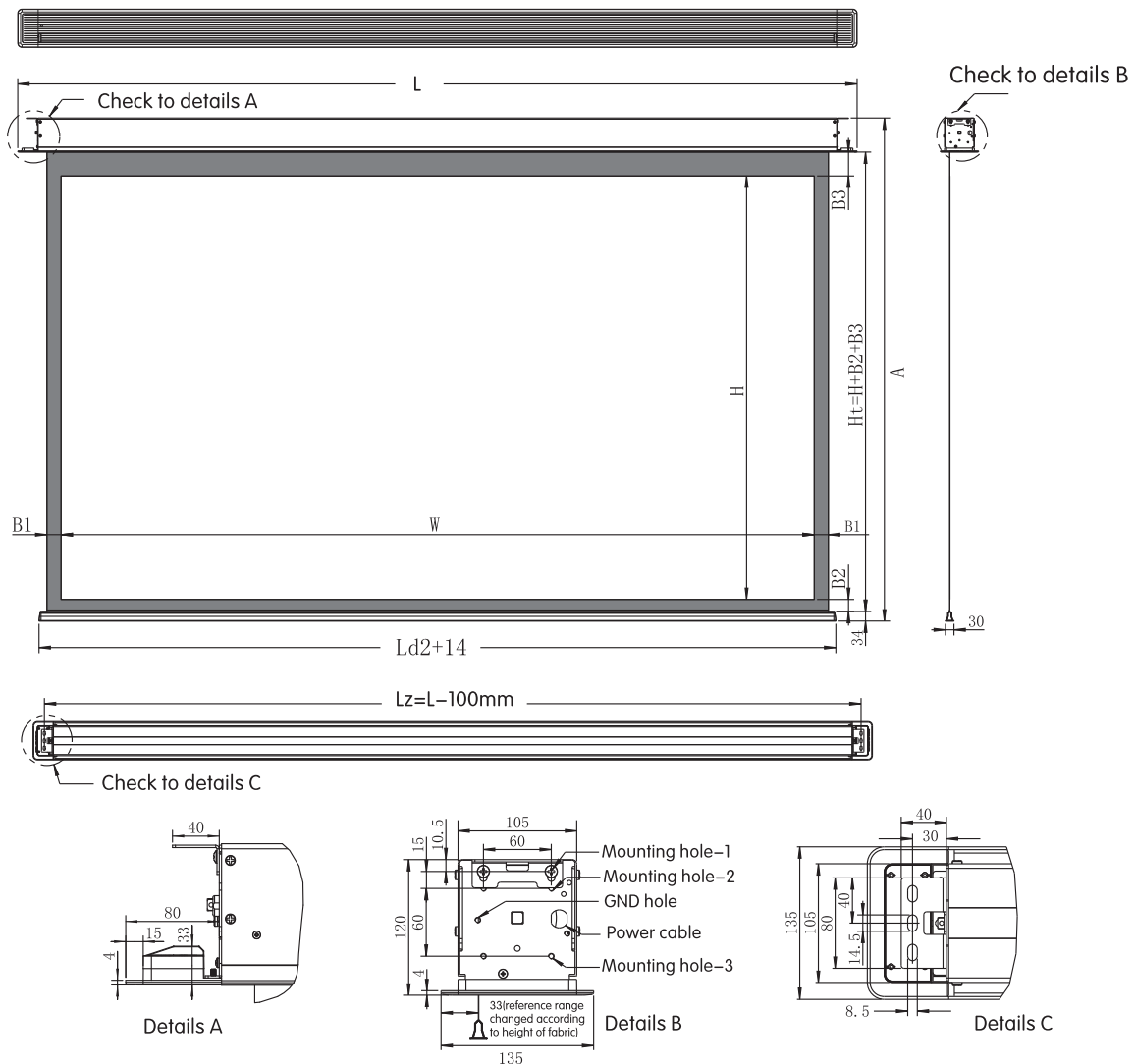

Installation distance: $Lz = \text{overall length}(L) - 100\text{mm}$
 Ceiling-cutting dimension: length (Lt) = overall length (L) - 20, 115mm in width, 122mm plus in height

Format	Hills Code	Specification	Viewing Area	L	A	Lz	Ld2	B1	B2	B3	Package L×H×W(mm)
		(Inch)	W×H (mm)	(mm)	(mm)		(mm)	(mm)	(mm)		
16:9	GRIPRC85H	85	1882x1058	2202	1841	2102	2036	50	30	600	2232 x 215 x 215
16:9	GRIPRC92H	92	2032x1146	2352	1929	2252	2186	50	30	600	2480 x 215 x 215
16:9	GRIPRC102H	102	2258x1270	2578	2053	2478	2412	50	30	600	2700 x 215 x 215
16:9	GRIPRC112H	112	2479x1395	2799	2178	2699	2633	50	30	600	2928 x 215 x 215
16:9	GRIPRC120H	120	2656x1494	2976	2277	2876	2810	50	30	600	3106x 215 x 215
16:9	GRIPRC130H	130	2878x1619	3188	2402	3088	3022	50	30	600	3328x 215 x 215
16:10	GRIPRC94C	94	2025x1265	2345	2048	2245	2179	50	30	600	2475x 215 x 215
16:10	GRIPRC103C	103	2219x1387	2539	2170	2439	2373	50	30	600	2600x 215 x 215
16:10	GRIPRC110C	110	2369x1481	2689	2264	2589	2523	50	30	600	2719x 215 x 215
16:10	GRIPRC120C	120	2585x1615	2905	2398	2805	2739	50	30	600	3035x 215 x 215
16:10	GRIPRC130C	130	2800x1750	3110	2533	3010	2944	50	30	600	3250x 215 x 215

Electrical data: AC220-230V/50-60Hz, 0.48A, 115W.
 Any change on function, structure or specification is without prior notice due to improvements on the product.
 Please refer to the specific product included.

Installation Instruction

This product is fit to install into all types of decoration ceilings. User could install the product according to different environments. The screen should be installed at the most proper place where it can work with projector. It is more convenient and safer for use when the screen is installed right and correctly.

Please unpack the packages and check if the fittings are correct in number and types. Please install the screen at proper place according to the installation instructions below.

1. Ceiling-cutting should be done at the position where the screen would be installed (diagram 1). The dimension of ceiling-cutting is 115mm in width, while it is 20mm shorter than the overall length. As to the grille ceiling, please take some pieces out of the ceiling (diagram 2) and cut them into pieces that would fit to the ceiling for re-installation after installation of the screen is finished.

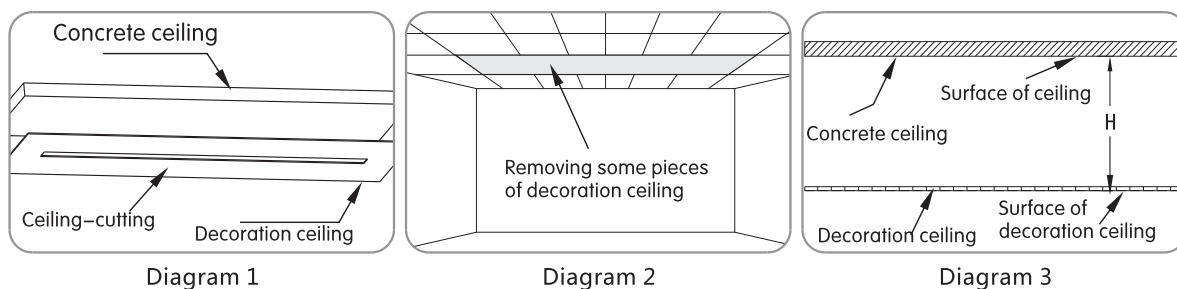

2. Please measure the height between surfaces of concrete ceiling and decoration ceiling (diagram 3) for optional installation modes:

- A. If the "H" is about 120mm, please install the screen directly onto concrete ceiling, see diagram 4;
- B. If the "H" is above 120mm, optional accessories including the hook and extended bolt are needed to complete installation, see diagram 5.

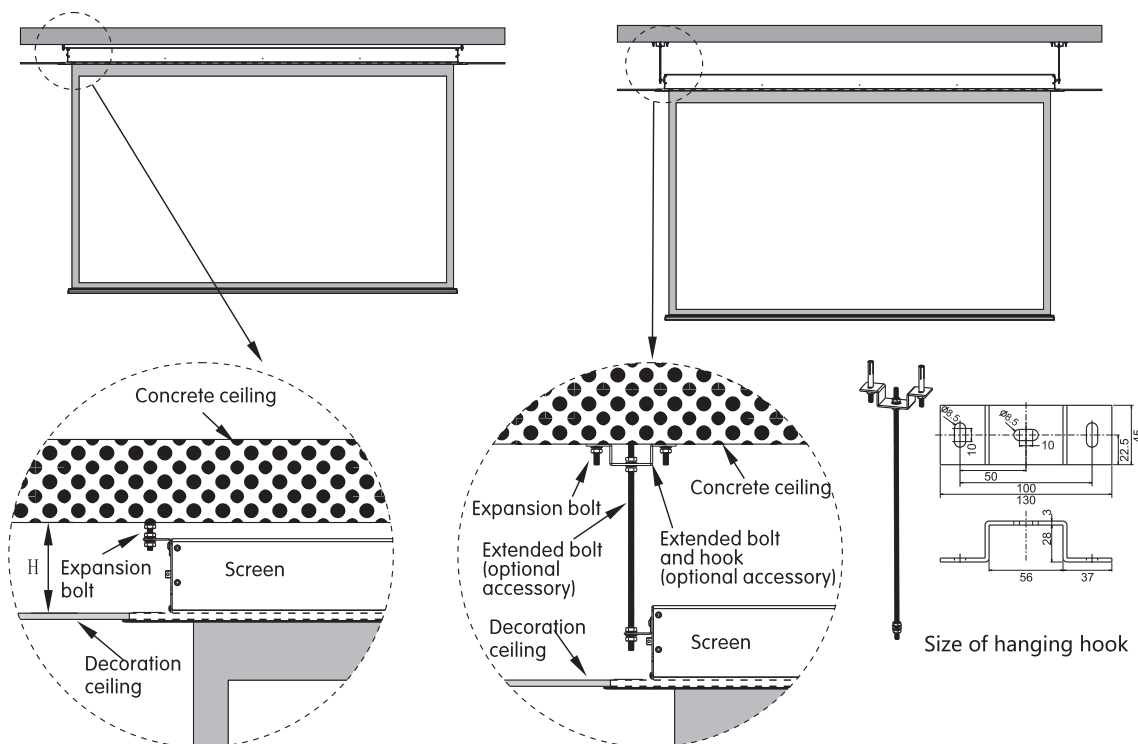

Diagram 4 For installation to low ceiling

Diagram 5 For installation to high ceiling

Installation Instruction

Note: Please make sure the concrete ceiling is strong enough to be bear the weight of 50kg or above before starting installation in order to avoid any damage on product or property lost and casualty due to insufficient bearing.

Note: Installation of the product must be completed by qualified technician(s), or it would result in damage, property lost and casualty.

3. According to the installation modes, please drill holes on concrete ceiling and fix expansion bolt (included in fitting pack) in model of M8*80 or longer one into the holes, see diagram 6 and 8; for high ceiling installation, hooks and extended bolts are needed to work with M8*60 expansion blot (optional accessories), see diagram 7 and 9;

Note: The center distance of two holes drilled for suspending purpose should strictly follow the actual dimension of the product, or the installation is not likely to be done; the distance from the two holes drilled for suspending purpose to both ends of the decoration ceiling should be the same. The suspending (installation) distance equals overall length of screen minus 80mm, please refer to the specification diagram for details.

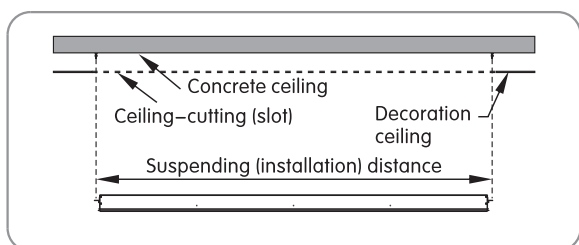

Diagram 6 Use screws for installation to low ceiling

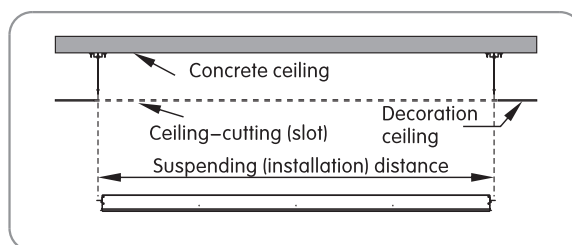

Diagram 7 Use hook for installation to high ceiling

4. Both of the installation modes need to put the extra M8 nuts and gaskets for adjustment on the height of installation, see diagram 8-9;

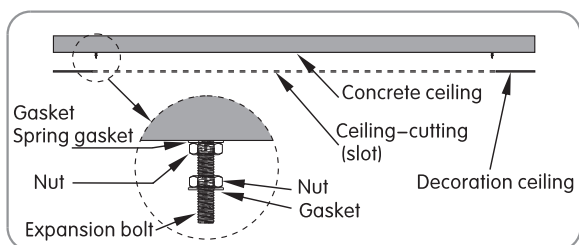

Diagram 8 Use screen for installation to low ceiling

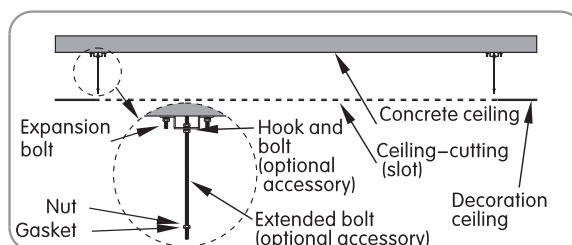

Diagram 9 Use hook for installation to high ceiling

5. Choose the sets of mounting holes for fixture according to the installation mode selected. Please use the M5*10 screws included in fitting pack to fix the screen. If the extended bolts are not needed in installation, please choose the first set of mounting holes for fixture, see diagram 10; for installation to high ceiling where extended bolts are applied, please choose the second mounting holes according to installation environment or apply the mounting brackets upside down for installation purpose, see diagram 11. The third mounting holes are only applied to ordinary motorized screen, while the intelligent motorized screen is not applicable due to the PCBA attached on the left end cap, see diagram 12.

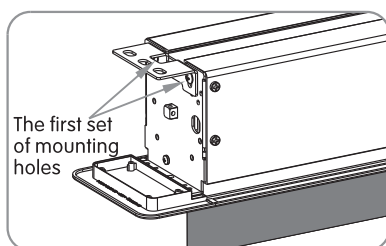

Diagram 10

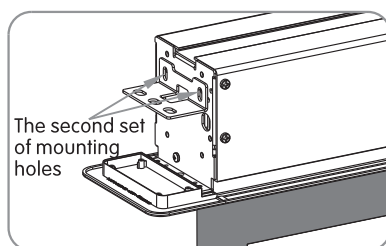

Diagram 11

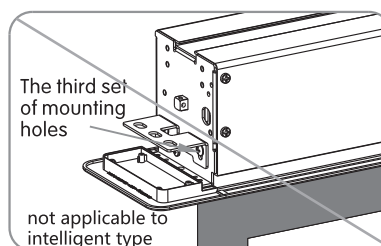

Diagram 12

Installation Instruction

6. Lift the screen and put it into the mounting holes pre-drilled. The fixing holes on two ends of installation plate should align to the expansion bolts or extended bolts on ceiling, see diagram 13–14.

Note: This step must be completed by two installers who should hold two ends of screen respectively when installation.

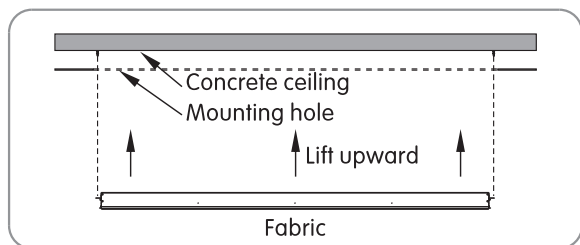

Diagram 13

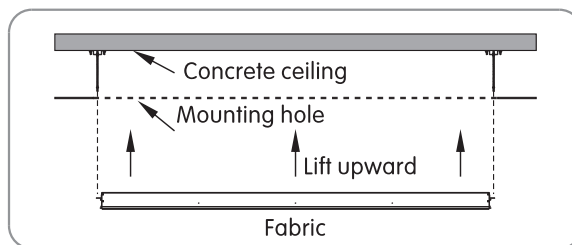

Diagram 14

7. Please put gasket, spring gasket and nut through the bolt, twist the nut for several rounds but not fasten it (diagram 15–16), and adjust the position of the nuts above and below the installation plate to get the front and back part of decoration board close enough to the decoration ceiling. Then please fasten the nut below the installation plate, see diagram 15–18.

Note: The screen must be operated in level condition. Please make necessary adjustment for screen to be horizontal when installing, or it would be likely to do damage to the screen.

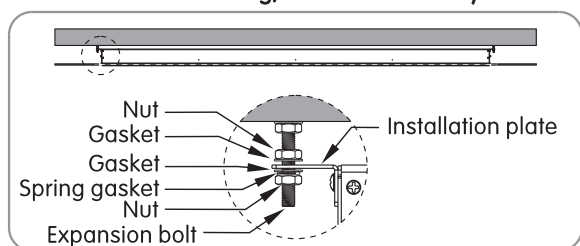

Diagram 15

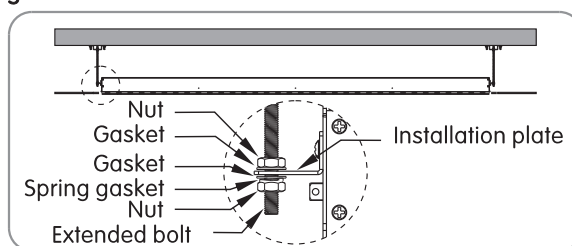

Diagram 16

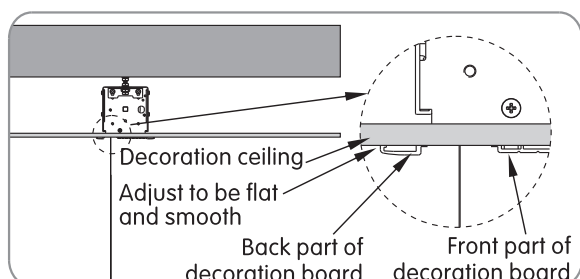

Diagram 17

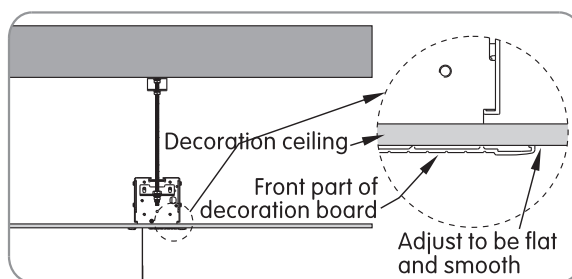

Diagram 18

Note:

Before connecting the products to power supply, please make sure the put-in voltage is in conformity with rated voltage of the product. It is recommended that supply power should be 2 times or above as much as the rated power of the product. Any improper power supply would lead to abnormal performance or even spoil the product.

8. Please fix the inline switch or external remote control receiving box where it is convenient to get access to. Then plug in the socket to connect to power supply.

9. Operate the screen to complete retraction and extension for once or twice to see if it is working normally before moving to next step of installation.

Installation Instruction

9. Power connect: connect the motor wire on the left hand side of screen to motor end on left end cap, then connect one end of the power cable to the AC IN and the other end to the AC socket, make sure they are connected firmly, see diagram 19-21.

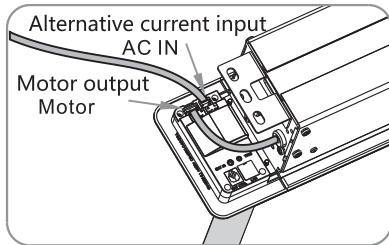

Diagram 19

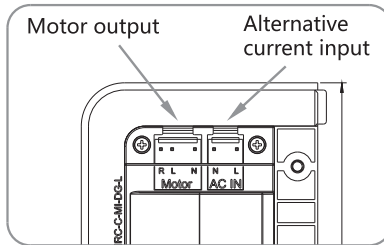

Diagram 20

Corresponding socket	terminal	Wiring instruction	Color for motor wiring	
			230V	120V
AC IN	L	Power phase line		
	N	Power null line		
Motor	N	Motor null line	Blue	White
	L	Motor down	Brown	Red
	R	Motor up	Black	Black

Diagram 21

10. Plug in screen and try not to touch anywhere with high voltage during operation such as AC IN end or Motor end. Press circled manual button on left end cap for several times to operate screen up and down for once or twice. If everything goes alright, please unplug the screen for the next step.

11. To install the left and right decoration cap, please kindly insert the legs (see diagram 23) aslant into slots of front and rear decoration board on the left and right end of screen (see diagram 24). Then push upwards lightly (see diagram 25) and fix the decoration cap firmly onto the bracket with M4*10 machine screws and screw cover. (see diagram 26-27).

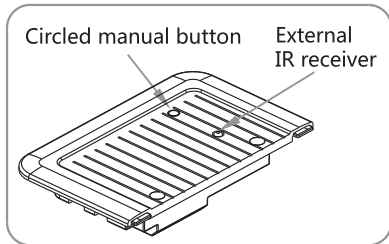

Diagram 22

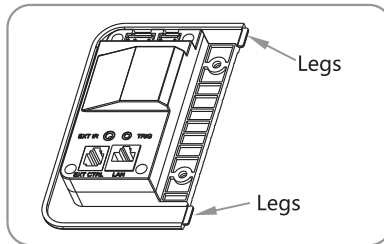

Diagram 23

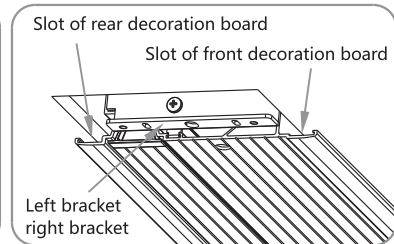

Diagram 24

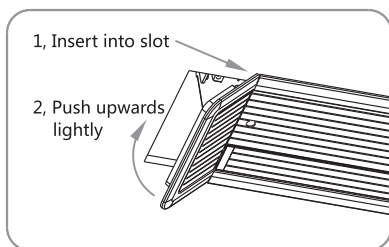

Diagram 25

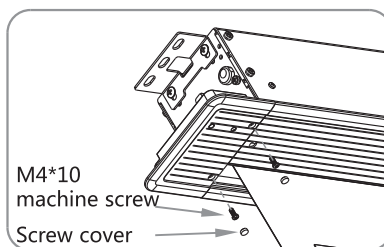

Diagram 26

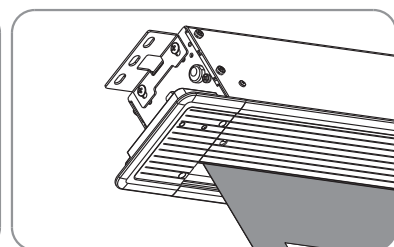

Diagram 27

Note:

Kindly distinguish left and right decoration caps by lines pattern. If installed correctly, the lines pattern on decoration caps should align with lines pattern on front and rear decoration boards. (see Diagram 28-30)

If there is apparent gaps appear, kindly push decoration caps towards till it reaches the end. (see diagram 30)

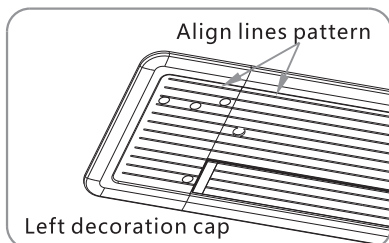

Diagram 28

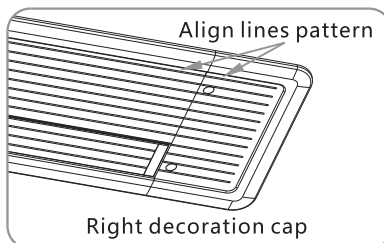

Diagram 29

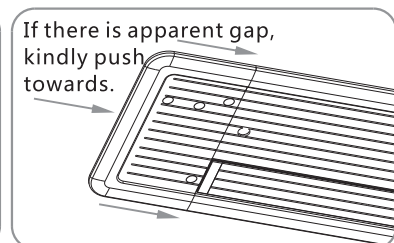

Diagram 30

Operation instruction

Multi-control systems are available for your optional accordingly

- IR remote control
- Manual control
- Dry contact control with wall switch
- RS-232/485 port
- 12V trigger wire
- External IR or RF converted to IR control
- Control with IP address (only available for IP control model)

1, IR remote control:

AC-127 model of IR controller:

- 1, Press "Up" button, screen retracts;
- 2, Press "Stop" button, screen stops;
- 3, Press "down" button, screen extends;
- 4, Press "Up" button for slight movement, screen goes up slightly;
- 5, Press "down" button for slight movement, screen goes down slightly.

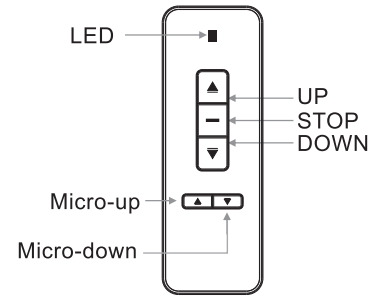

Model: AC-127

Note for emitter

- 1, Kindly point the emitter to receiver on left end cap. The control distance is about 8 meters;
- 2, The control angle is 30 degrees from the central direction of emitter, see diagram 31;
- 3, The control angle is within plus minus 30 degrees from the central direction of receiver, see diagram 32-33;
- 4, There should not be anything to block or cover the emitter and receiver;
- 5, Nothing should block out emitter end and receiver end because of straight transmission of IR signals.
- 6, Don't use the emitter in environment of humidity or high temperature.
- 7, Battery would need to be replaced when control distance is shorten apparently or the light of indicator is turning dim.

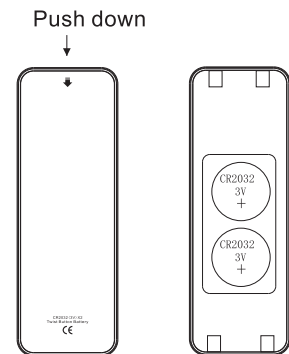

Replacement battery for emitter

Please replace battery when the signal becomes weak:

Note: Emitter is used with 2 pcs of button cells with model of CR2032; Do not mix the new and old button cells for use.

- 1, Turn over the emitter and remove the cover by pushing to the direction indicated by arrow;
- 2, Install the button cells according to positive and negative charges indicated;
- 3, Install the cover.

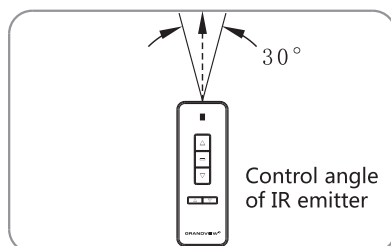

Diagram 31

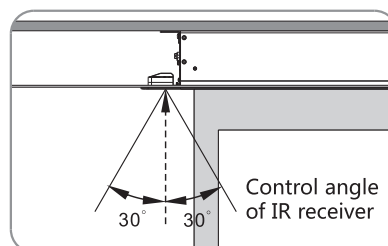

Diagram 32

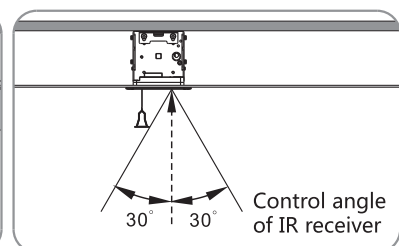

Diagram 33

Operation instruction

2.Manual control

Manual control button is available in case the remote controller is not at hands. The manual button is located below the left end cap. (see diagram 34). By pressing the manual button, screen would circle the operation of extension-stop-retraction.

External control (dry contact or RS232, GrandView wall switch)

Connect the crystal head of signal wire into EXT CTRL on left end cap of screen, and the other end of signal wire would be connected to central control application, computer RS232 port or GrandView wall switch (see diagram 35-39) to control the screen. See diagram 35 for control port of the screen. See diagram 36 for connection of signal wire with crystal head.

3.See diagram 37 for control for low voltage dry contact.

4.Control with RS-232/485 port

See diagram 38 for connection of signal wire between EXT CTRL and computer or central control application of RS232/485 port. Screen could be controlled by sending corresponding commands. See diagram 39 for port setting and commands.

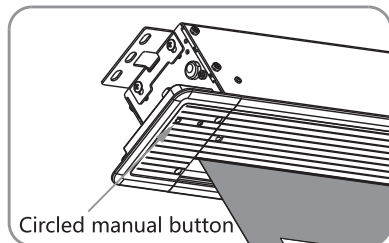

Diagram 34

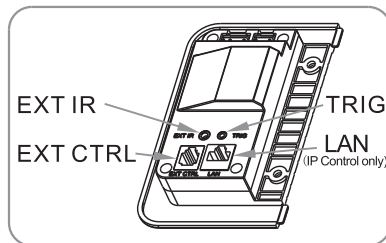

Diagram 35

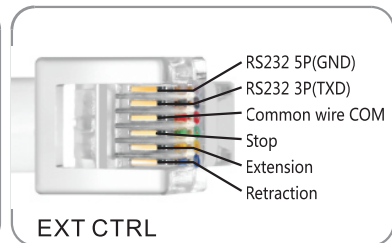

Diagram 36

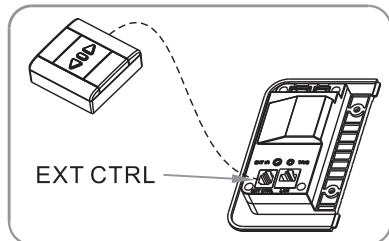

Diagram 37

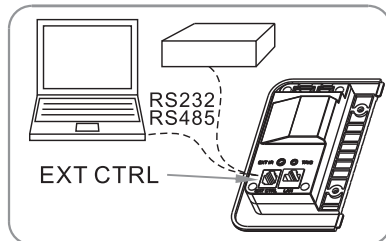

Diagram 38

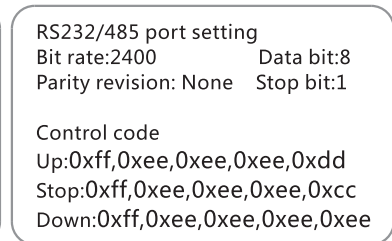

Diagram 39

5. Control with 12V trigger wire

Connect the trigger wire (optional accessory) to the "TRIG" hole on left end cap of screen with one end, insert the other end into 12V output hole on projector, see diagram 40; screen would extends when projector is turned on, while screen would retract when projector is turned off.

Note: Read user manual for projector in advance to make sure there is 12V output signal from projector.

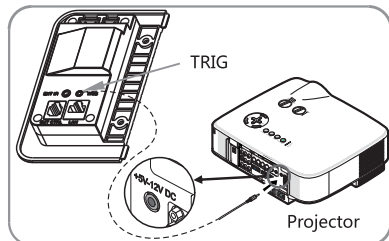

Diagram 40

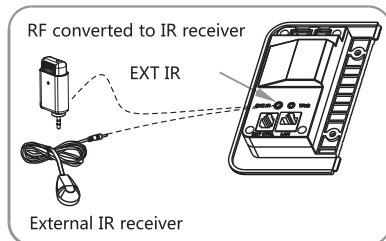

Diagram 41

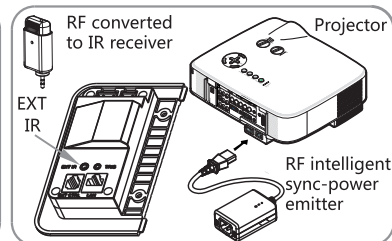

Diagram 42

Adjustment

Instruction of adjusting the retraction and extension limit

1. The default retraction limits are perfect settings, we do not recommend adjustment to avoid potential damage to the product, please talk to after sales team for further advice.
2. If you do need adjust the extension limit, you can do that through the slot underneath the right hand side of the screen, with below instructions:

WARNING

Please pay attention when adjusting retraction. Over-retraction is avoided in order not to spoil the motor and screen; please also pay attention when adjusting extension. The fabric should be rolled at least one and a half rounds onto the shaft to avoid the fabric fall off. After the adjustment is done, the difference of retraction and extension limit might not be found at once until the screen is operated for several times.

Adjustment of extension (lower limit).

Press the "down" button of the controller and the screen would extend. Insert the adjuster key into the positioner adjusting hole in yellow color on motor to make adjustment. Stand opposite to positioner adjusting hole and turn adjuster key clockwise to make fabric retract slightly, while turn counter clockwise to make fabric a little extension for adjustment.

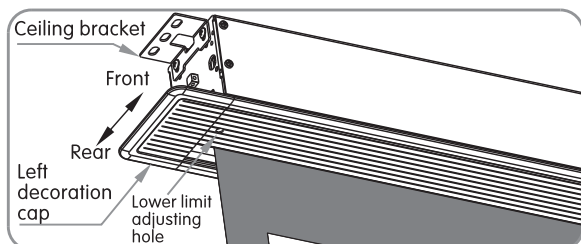

Diagram 32

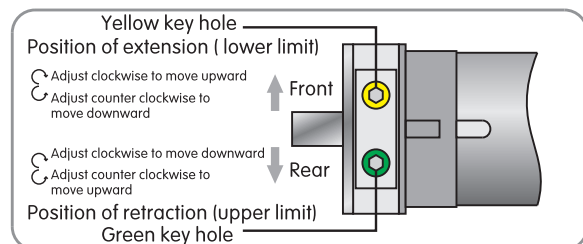

Diagram 33

Due to the special structure of the product, default of "retraction limit" has been perfectly set and it is not recommended to make adjustment by user so as not to damage the screen because of improper adjustment on retraction limit. Any damage out of this operation is not under warranty for the product.

Adjustment of retraction (upper limit).

Press the "up" button of the controller and the screen would retract. When the fabric rod goes nearby or enters the case, please insert the adjuster key (slight adjustment on direction is needed when insert adjuster key until the key enter correctly into the green hole) into the positioner adjusting hole in green color on motor to make adjustment. Stand opposite to positioner adjusting hole and turn adjuster key clockwise to make fabric extend slightly, while turn counter clockwise to make fabric a little retraction for adjustment.

Note on upper limit adjustment:

The decoration board of this product can completely cover the exit of the case and there is springs installed on the integration of fabric rod, which is different from other series of screens.

When adjusting the upper limit, please make sure decoration board could be completely closed. Enough space is needed for decoration board to move freely. Setting the upper limit to be too high would come to damage the fabric or motor.

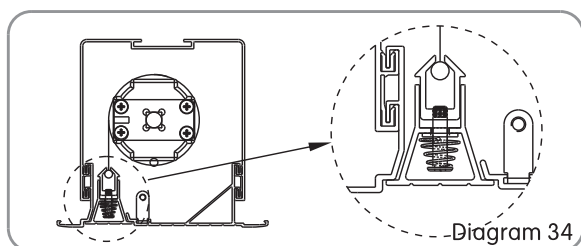

Diagram 34

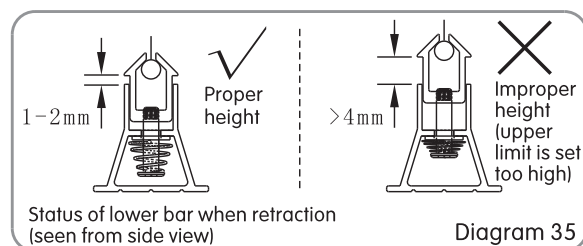

Diagram 35

Protecting Your Screen:

- Keep away from direct sunlight or high temperatures.
- Examine both the front and back surfaces before retracting into the case to make sure it is free of dust, dirt, insects or other foreign matter.
- Use a soft brush or cloth to lightly remove any foreign particles.

Cleaning Your Screen:

- Do not use any solvents, chemicals or abrasive cleaners on the screen surface.
- Use a mild detergent with warm water to remove any marks on the surface or screen case.
- Always immediately dab the screen with a soft cloth to avoid soap marks.
- Do not scrub the surface.