

## User's Guide

**EH-TW6800**

**EH-TW6700W**

**EH-TW6700**

**EH-TW6300**

Home Projector

---

## Using Each Guide

The guides for this projector are organized as shown below.

### Safety Instructions/Support and Service Guide

Contains information on using the projector safely, as well as a support and service guide, troubleshooting check lists, and so on. Make sure you read this guide before using the projector.



### User's Guide (this guide)

Contains information on setting up and basic operations before using the projector, using the Configuration menu, and handling problems and performing routine maintenance.



### Quick Start Guide

Contains information on the procedures for setting up the projector. Read this first.

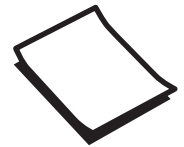

### 3D Glasses User's Guide

Contains information on handling the 3D Glasses and warnings and so on.

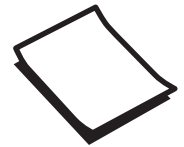

### WirelessHD Transmitter User's Guide (EH-TW6700W only)

Contains information on handling the WirelessHD Transmitter and warnings and so on.

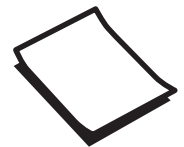



# Notations Used in This Guide

## Safety Indications

The documentation and the projector use graphical symbols to show how to use the projector safely. The following shows the symbols and their meanings. Please understand and respect these caution symbols in order to avoid injury to persons or property.

### Warning

This symbol indicates information that, if ignored, could possibly result in personal injury or even death due to incorrect handling.



### Caution

This symbol indicates information that, if ignored, could possibly result in personal injury or physical damage due to incorrect handling.

## General Information Indications

### Attention

Indicates procedures which may result in damage or malfunctions to occur.

	Indicates additional information and points which may be useful to know regarding a topic.
	Indicates a page where detailed information regarding a topic can be found.
Menu Name	Indicates Configuration menu items. Example: <b>Image - Color Mode</b>
Button Name	Indicates the buttons on the remote control or the control panel. Example:  button

## About the Use of "This Product" or "This Projector"

As well as the main projector unit, supplied items or optional extras may be referred to using the phrase "this product" or "this projector".

## Organization of the Guide and Notations in the Guide

<b>Using Each Guide</b> .....	<b>1</b>
<b>Notations Used in This Guide</b> .....	<b>2</b>
Safety Indications .....	2
General Information Indications .....	2
About the Use of "This Product" or "This Projector" .....	2

## Introduction

<b>Projector Features</b> .....	<b>6</b>
Dynamic 3D Display .....	6
Project Images from Mobile Devices .....	6
Other Useful Functions .....	6
<b>Part Names and Functions</b> .....	<b>7</b>
Front/Top .....	7
Control panel .....	8
Remote Control .....	10
Rear .....	13
Base .....	14

## Preparing

<b>Installing</b> .....	<b>15</b>
Projected Image and Position of Projector .....	15
Installing in parallel with the screen .....	15
Installing the projector horizontally by adjusting the height of either side .....	15
Various Setting Methods .....	16
Placing on a table and projecting .....	16
Suspending from the ceiling and projecting ..	16
Projection Distance and Lens Shift Maximum Values .....	17
<b>Connecting a Device</b> .....	<b>20</b>
Connecting Video Equipment .....	20
Connecting a Computer .....	20
Connecting Smartphones or Tablets .....	20
Connecting USB devices .....	21
Connecting External Equipment .....	22
Connecting Bluetooth® devices .....	22
Connecting external speakers (EH-TW6700W/EH-TW6700/EH-TW6300 only) .....	24

Connecting WirelessHD devices (EH-TW6700W only) .....	24
Connecting to the Trigger Out port (EH-TW6800 only) .....	25
Connecting to the LAN port (EH-TW6800 only) .....	25
Attaching the Wireless LAN unit .....	26
Removing the Terminal Cover .....	26

## Preparing the Remote Control .....

Installing the Remote Control Batteries .....	27
Remote Control Operating Range .....	27
Operating range (left to right) .....	27
Operating range (top to bottom) .....	27

## Basic Operations

### Projecting Images .....

Turning On the Projector .....	28
If the target image is not projected .....	28
Using the Home Screen .....	29
Turning Off .....	30

### Adjusting the Projected Image .....

Displaying the Test Pattern .....	31
Adjusting the Focus .....	31
Adjusting the Projection Size (Adjust Zoom) ..	31
Adjusting the Projector's Tilt .....	32
Adjusting the Position of the Image (Lens Shift) ..	32
Correcting Keystone Distortion .....	33
Correcting using the Keystone button .....	34
Correcting with Quick Corner .....	34
Adjusting the Volume .....	35
Hiding the Image and Muting the Audio Temporarily (A/V Mute) .....	36

## Adjusting the Image

### Adjusting the Image .....

Selecting the Projection Quality (Color Mode) ..	37
Switching the Screen Between Full and Zoom (Aspect) .....	38
Adjusting the Sharpness .....	39
Adjusting Image Resolution (Image Enhancement) .....	40



Setting Auto Iris . . . . .	41
Setting Frame Interpolation . . . . .	41
Setting the Image Processing Speed . . . . .	42
<b>Adjusting the Color . . . . .</b>	<b>43</b>
Adjusting the Color Temp. . . . .	43
Adjusting the RGB (Offset and Gain) . . . . .	43
Adjusting Hue, Saturation, and Brightness . . . . .	43
Adjusting the Gamma . . . . .	45
Select and adjust the correction value . . . . .	45
Adjust while viewing the image . . . . .	45
Adjust using the gamma adjustment graph . . . . .	46
<b>Viewing the Image at the Saved Image Quality (Memory Function) . . . . .</b>	<b>47</b>
Saving a Memory . . . . .	47
Loading, Deleting, and Renaming a Memory . . . . .	47
<b>Useful Functions</b>	
<hr/>	
<b>Enjoying 3D Images . . . . .</b>	<b>49</b>
Preparing to View 3D Images . . . . .	49
If the 3D image cannot be viewed . . . . .	49
Using 3D Glasses . . . . .	50
Charging the 3D Glasses . . . . .	50
Pairing 3D Glasses . . . . .	51
Wearing 3D Glasses . . . . .	52
Reading the indicator on the 3D Glasses . . . . .	52
Converting 2D Images to 3D . . . . .	52
Warnings Regarding Viewing 3D Images . . . . .	53
<b>Connecting with WirelessHD (EH-TW6700W Only) . . . . .</b>	<b>56</b>
Installing the WirelessHD Transmitter . . . . .	56
WirelessHD Transmitter part names . . . . .	57
WirelessHD Transmitter connection example and signal flow . . . . .	58
Setting the WirelessHD Transmitter . . . . .	63
Projecting Images . . . . .	63
WirelessHD Settings Menu . . . . .	65
WirelessHD Transmission Range . . . . .	66
Operating the Remote Control . . . . .	67
Remote Control Operating Range . . . . .	67
Switching the Input and Output . . . . .	67

Switching the target image . . . . .	68
Switching the image source . . . . .	69
<b>Using the HDMI Link Function . . . . .</b>	<b>70</b>
HDMI Link Function . . . . .	70
HDMI Link Settings . . . . .	70
Connecting . . . . .	71
<b>Playing Back Image Data (Slideshow) . . . . .</b>	<b>72</b>
Compatible Data . . . . .	72
Starting a Slideshow . . . . .	72
Settings for Slideshow . . . . .	72
<b>Projecting Two Different Images Using Picture in Picture . . . . .</b>	<b>74</b>
Types of Screen that can be Displayed Simultaneously . . . . .	74
Projecting on a Picture in Picture . . . . .	74
Starting and exiting Picture in Picture . . . . .	74
Changing the Picture in Picture settings . . . . .	75
<b>Using the Projector on a Network</b>	
<hr/>	
<b>Projecting Using Wired LAN (EH-TW6800 Only) . . . . .</b>	<b>76</b>
Selecting Wired Network Settings . . . . .	76
<b>Projecting Using Wireless LAN . . . . .</b>	<b>78</b>
Selecting Wireless Network Settings Manually . . . . .	78
Selecting the Computer's Wireless LAN Settings . . . . .	80
Selecting wireless network settings in Windows . . . . .	80
Selecting wireless network settings in OS X . . . . .	80
Setting Up Wireless Network Security . . . . .	81
Projecting in Epson iProjection . . . . .	81
Operating using a smartphone (remote control function) . . . . .	82
<b>Configuration Menu</b>	
<hr/>	
<b>Configuration Menu Functions . . . . .</b>	<b>85</b>
Configuration Menu Operations . . . . .	85
Configuration Menu Table . . . . .	86
Image menu . . . . .	86
Signal menu . . . . .	88
Settings menu . . . . .	89
Extended menu . . . . .	92

Network menu ..... 95  
 Info menu ..... 99  
 Reset menu ..... 100

**Troubleshooting**

**Problem Solving ..... 101**  
 Reading the Indicators ..... 101  
     Indicator status during an error/warning . . . 101  
     Indicator status during normal operation . . . 102  
 When the Indicators Provide No Help ..... 103  
     Check the problem ..... 103  
     Problems relating to images ..... 105  
     Noise problems ..... 108  
     Problems when projection starts ..... 109  
     Problems with the remote control ..... 109  
     Problems with the control panel ..... 109  
     Problems with 3D ..... 110  
     Problems with HDMI ..... 110  
     Bluetooth device problems ..... 111  
     Problems with WirelessHD (EH-TW6700W only) ..... 112  
     Network problems ..... 113  
 About Event ID ..... 114

**Maintenance**

**Maintenance ..... 116**  
 Cleaning the Parts ..... 116  
     Cleaning the air filter ..... 116  
     Cleaning the main unit ..... 117  
     Cleaning the lens ..... 118  
     Cleaning the 3D Glasses ..... 118  
 Replacement Periods for Consumables ..... 118  
     Air filter replacement period ..... 118  
     Lamp replacement period ..... 118  
 Replacing Consumables ..... 119  
     Replacing the air filter ..... 119  
     Replacing the lamp ..... 120  
     Resetting lamp hours ..... 121  
**Panel Alignment ..... 123**  
**Color Uniformity (EH-TW6800 Only) . . 125**

**About PJLink (EH-TW6800 Only) ..... 127**

**Appendix**

**Optional Accessories and Consumables ..... 128**  
     Optional Items ..... 128  
     Consumables ..... 128  
**Supported Resolutions ..... 129**  
     Computer Signals (Analog RGB) ..... 129  
     HDMI1/HDMI2 Input Signal ..... 129  
     MHL Input Signal ..... 129  
     3D Input Signal HDMI ..... 130  
     3D Input Signal MHL ..... 130  
     WirelessHD Input Signal ..... 130  
     WirelessHD\* Input Signal MHL ..... 130  
**Specifications ..... 132**  
     EH-TW6800/EH-TW6300 ..... 132  
     EH-TW6700W/EH-TW6700 ..... 133  
**Appearance ..... 136**  
**List of Safety Symbols ..... 137**  
     Maximum radio-frequency power transmitted . 139  
**Glossary ..... 140**  
**General Notes ..... 141**  
     General Notice ..... 142

# Projector Features

## Dynamic 3D Display

Enjoy 3D contents on Blu-ray and images filmed with a 3D camera through a stunning projection display.  [p.49](#)

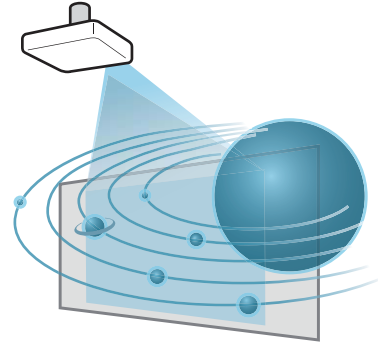

## Project Images from Mobile Devices

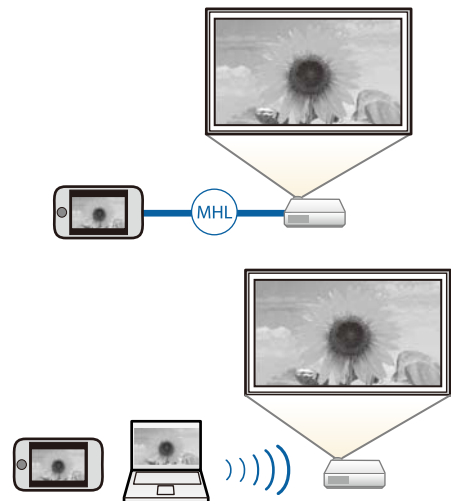

HDMI2/MHL port to connect a commercially available MHL cable to the mobile device and to the projector.

By using Epson iProjection, you can wirelessly connect the projector to smartphones and tablets. You can download Epson iProjection for free from the App Store or from Google play.  [p.81](#)



## Other Useful Functions

In addition, the following useful functions are provided.

- Playing audio through the internal speaker. This allows you to enjoy audio without an external speaker. (EH-TW6700W/EH-TW6700 only)
- You can view slideshows by simply connecting a USB memory to the projector. When a digital camera is connected, you can view the photos on the camera using **Slideshow**.  [p.72](#)
- Operate by remote control from a smartphone. By using Epson iProjection, you can operate the projector from a smartphone or tablet.  [p.82](#)

# Part Names and Functions

## Front/Top

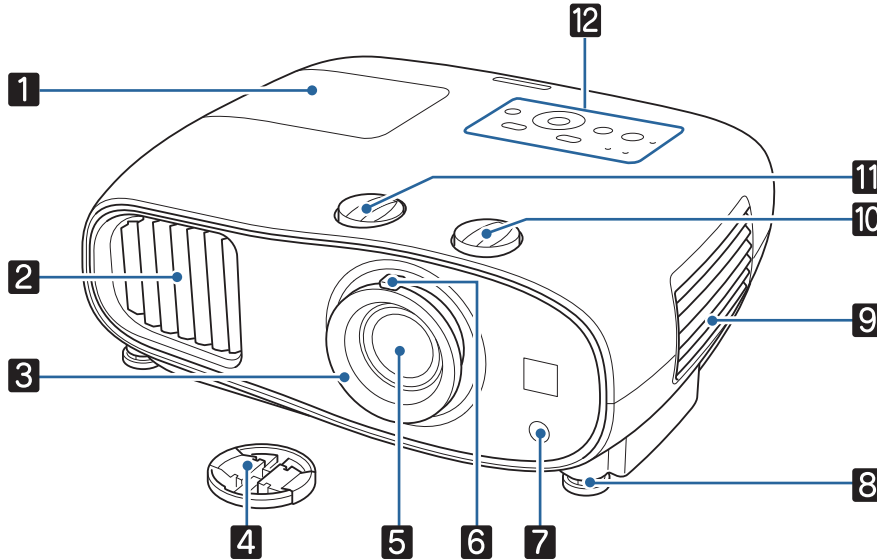









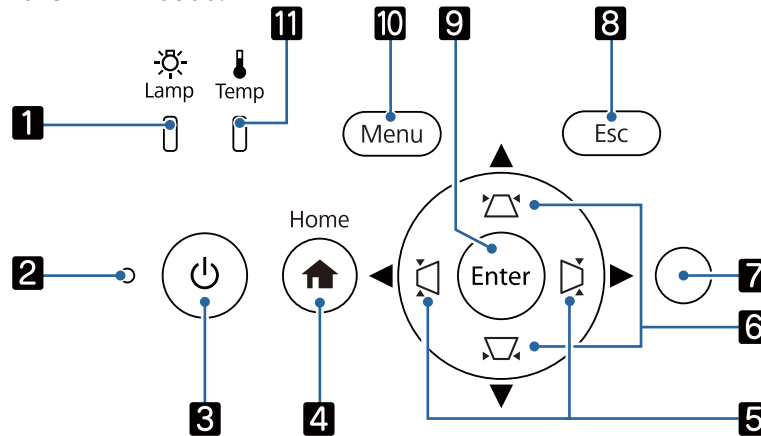

Name		Function
<b>1</b>	Lamp cover	Open when replacing the projector's lamp. <a href="#">p.120</a>
<b>2</b>	Air exhaust vent	Exhaust vent for air used to cool the projector internally.  <div style="border: 1px solid black; padding: 5px;"> <p><b>Caution</b></p> <p>While projecting, do not put your face or hands near the air exhaust vent, and do not place objects that may become warped or damaged by heat near the vent. Hot air from the air exhaust vent could cause burns, warping, or accidents to occur.</p> </div>
<b>3</b>	Focus ring	Adjusts the image focus. <a href="#">p.31</a>
<b>4</b>	Lens cap	Install when not using the projector to protect the lens from being scratched or soiled. <a href="#">p.28</a>
<b>5</b>	Lens	Images are projected from here.
<b>6</b>	Zoom ring	Adjusts the image size. <a href="#">p.31</a>
<b>7</b>	Remote receiver	Receives signals from the remote control. <a href="#">p.27</a>
<b>8</b>	Front adjustable foot	When set up on a surface such as a table, extend the foot to adjust horizontal tilt. <a href="#">p.32</a>
<b>9</b>	Air filter cover	When cleaning or replacing the air filter, open this cover and remove the air filter. <a href="#">p.116</a> <a href="#">p.119</a>
	Air intake vent	Intake vent for air used to cool the projector internally.
<b>10</b>	Vertical lens shift dial	Turn the dial to move the position of the projected image up or down. <a href="#">p.32</a>
<b>11</b>	Horizontal lens shift dial	Turn the dial to move the position of the projected image left or right. <a href="#">p.32</a>





Name	Function
<b>12</b> Control panel	Operates the projector. 🖱️ <a href="#">p.8</a>

## Control panel

The control panel varies depending on the projector model you are using. The examples in this section are for the control panel for the EH-TW6800.



Buttons/Indicators	Function
<b>1</b> 	Flashes orange when it is time to replace the lamp. Shows the projector's errors through a combination of other indicators lit and flashing. 🖱️ <a href="#">p.101</a>
<b>2</b>  Operation indicator	Flashes to indicate the projector is warming up or cooling down. Shows the projector's status through a combination of other indicators lit and flashing. 🖱️ <a href="#">p.101</a>
<b>3</b> 	Turns the projector on or off. 🖱️ <a href="#">p.28</a> Lit when the projector is on. Shows the projector's status through a combination of other indicators lit and flashing. 🖱️ <a href="#">p.102</a>
<b>4</b>  Home	Displays and closes the Home screen. 🖱️ <a href="#">p.29</a>
<b>5</b>  EH-TW6800/EH-TW6300 : EH-TW6700W/EH-TW6700 : 	<ul style="list-style-type: none"> <li>Adjusts the volume. (EH-TW6700W/EH-TW6700 only) You cannot control the volume for Bluetooth audio devices. 🖱️ <a href="#">p.35</a></li> <li>Selects menu items or adjustment values while displaying the projector's menu. 🖱️ <a href="#">p.85</a></li> <li>When the Keystone screen is displayed, you can adjust horizontal distortion in the projected image. 🖱️ <a href="#">p.33</a></li> </ul>
<b>6</b> 	<ul style="list-style-type: none"> <li>Selects menu items or adjustment values while displaying the projector's menu. 🖱️ <a href="#">p.85</a></li> <li>Adjusts keystone distortion in projected images. 🖱️ <a href="#">p.33</a></li> </ul>
<b>7</b>  Brightness sensor	Detects the brightness of the room. When <b>Color Mode</b> is set to <b>Auto</b> , the optimum image quality is set according to the brightness detected by the sensor. 🖱️ <a href="#">p.37</a>
<b>8</b>  Esc	Returns to the previous menu level when a menu is displayed. 🖱️ <a href="#">p.85</a>
<b>9</b>  Enter	Selects functions and settings when a menu is displayed. 🖱️ <a href="#">p.85</a>

	Buttons/Indicators	Function
10		Displays and closes the Configuration menu. On the Configuration menu, you can make adjustments and settings for Signal, Image, and so on.  <a href="#">p.85</a>
11	 Temp	Flashes orange if the internal temperature is too high. Shows the projector's errors through a combination of other indicators lit and flashing.  <a href="#">p.101</a>



When the Illumination function is set to **Off**, all indicators are off under normal projection conditions.  **Extended - Operation - Illumination** [p.92](#)

# Remote Control

The remote control varies depending on the projector model you are using. This examples in this section are for the remote control for the EH-TW6700W.

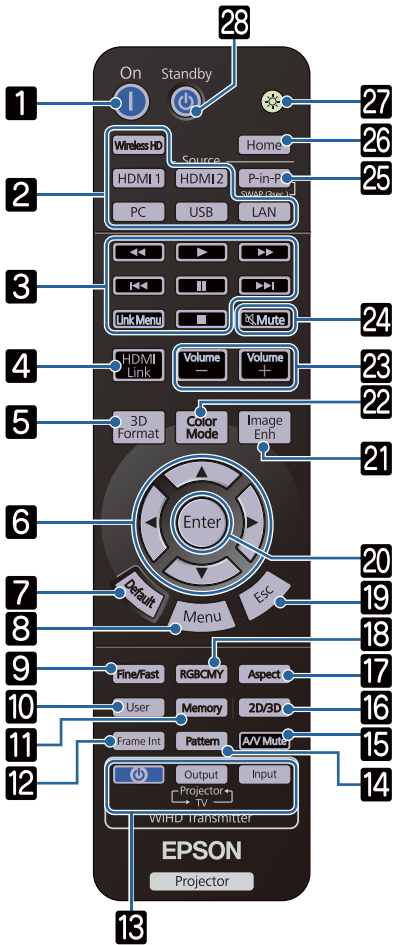

Button	Function
<b>1</b> 	Turns the projector on. <a href="#">p.28</a>
<b>2</b> 	Changes to the image from each input port. <a href="#">p.28</a> <i>WirelessHD</i> button is only available for EH-TW6700W.
<b>3</b> 	Performs operations such as play and stop for connected devices that meet the HDMI CEC standards. <a href="#">p.70</a>
<b>4</b> 	<ul style="list-style-type: none"> <li>When <b>HDMI Link</b> is <b>On</b> Displays the device connections list.</li> <li>When <b>HDMI Link</b> is <b>Off</b> Displays the HDMI link settings menu.</li> </ul> <a href="#">p.70</a>
<b>5</b> 	Changes the 3D format. This projector supports the following 3D formats. <ul style="list-style-type: none"> <li>Frame Packing</li> <li>Side by Side</li> <li>Top and Bottom</li> </ul> <a href="#">p.49</a>
<b>6</b> 	Selects menu items and adjustment values. <a href="#">p.85</a>
<b>7</b> 	The adjustment value returns to its default value when pressed while the menu's adjustment screen is displayed. <a href="#">p.85</a>

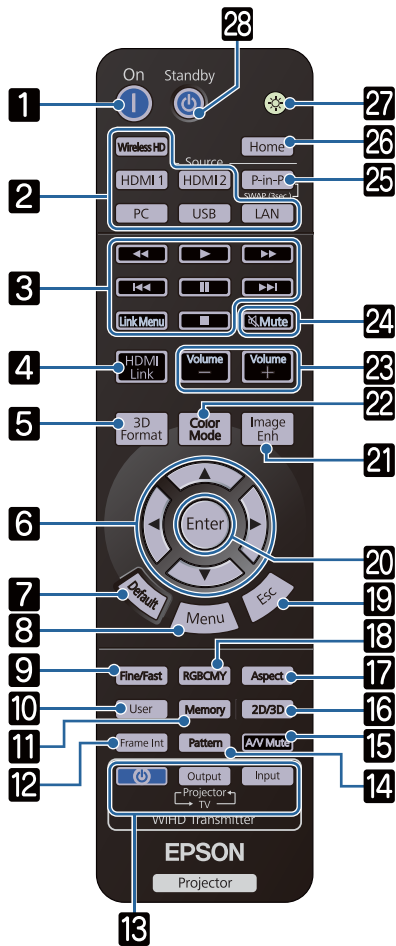

Button	Function
8	Menu Displays and closes the Configuration menu. On the Configuration menu, you can make adjustments and settings for Signal, Image, and so on. <a href="#">p.85</a>
9	Fine/Fast Smoothly projects images with a quick frame rate, such as games. <a href="#">p.42</a>
10	User Performs the function assigned to the user button. <a href="#">p.89</a>
11	Memory Saves, loads, or erases a memory. <a href="#">p.47</a>
12	Frame Int Sets the strength for Frame Interpolation. <a href="#">p.41</a>
13	(Only available for EH-TW6700W) Output Input This is the button for controlling the WirelessHD Transmitter. Turns on the WirelessHD Transmitter, or switches the input and output. Make sure you point the remote control at the WirelessHD Transmitter when performing operations. <a href="#">p.56</a>
14	Pattern Displays and closes the test pattern. <a href="#">p.31</a>
15	A/V Mute Temporarily hides or shows the image and audio. <a href="#">p.36</a>
16	2D/3D Changes between 2D and 3D. <a href="#">p.49</a>
17	Aspect Selects the aspect mode according to the input signal. <a href="#">p.38</a>
18	RGBCMY Adjusts the hue, saturation, and brightness for each RGBCMY color. <a href="#">p.43</a>
19	Esc Returns to the previous menu level when a menu is displayed. <a href="#">p.85</a>
20	Enter When a menu is displayed, it accepts and enters the current selection and moves to the next level. <a href="#">p.85</a>
21	Image Enh Displays the <b>Image Enhancement</b> menu. <a href="#">p.40</a>
22	Color Mode Changes the <b>Color Mode</b> . <a href="#">p.37</a>
23	Volume - Volume + Adjusts the volume. <a href="#">p.35</a>
24	Mute Temporarily mutes or plays the audio. <a href="#">p.36</a>



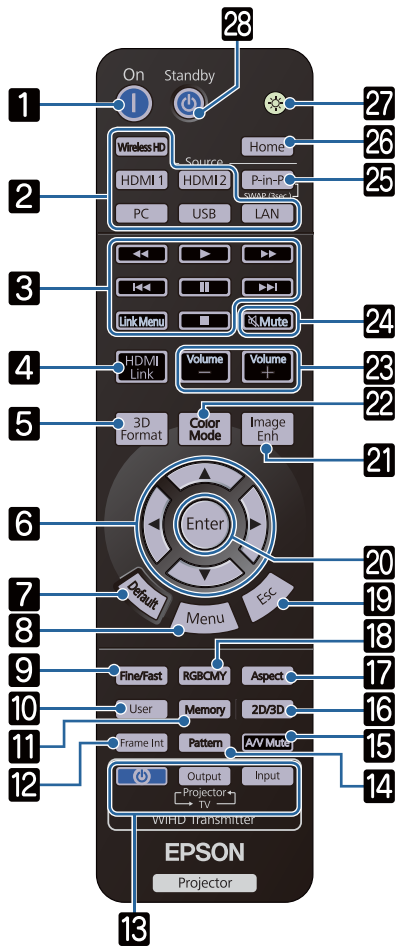

Button	Function
25	<p><b>P-in-P</b></p> <p>Allows you to simultaneously project two image sources, one in the main screen and the other in the sub screen. (Picture in Picture)  <a href="#">p.74</a></p> <p>Press and hold the button to swap the main or sub screen image sources.</p>
26	<p><b>Home</b></p> <p>Displays and closes the Home screen.  <a href="#">p.29</a></p>
27	<p></p> <p>The remote control buttons light up for approximately 10 seconds. This is useful when operating the remote control in the dark.</p>
28	<p><b>Standby</b></p> <p></p> <p>Turns the projector off.  <a href="#">p.30</a></p>

## Rear

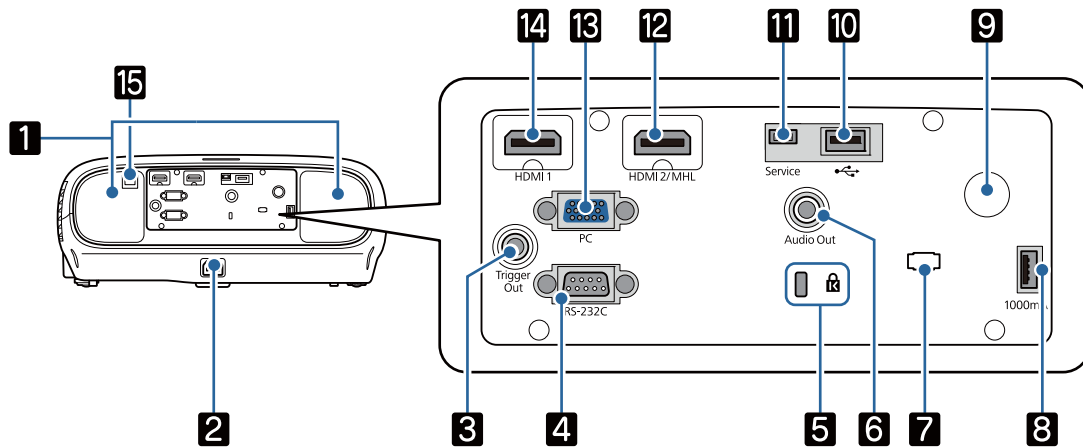

Name		Function
<b>1</b>	Speaker (EH-TW6700W/EH-TW6700 only)	The projector's built-in speaker. Outputs audio. Set <b>Inverse Audio</b> to <b>On</b> to use the built-in speaker when the projector is suspended from a ceiling. ☛ <b>Settings - Audio - Inverse Audio</b> p.89
<b>2</b>	Power inlet	Connect the power cord. ☛ p.28
<b>3</b>	Trigger Out port (EH-TW6800 only)	Connects with external devices such as motorized screens. ☛ p.25
<b>4</b>	RS-232C port (EH-TW6800 only)	When controlling the projector, connect the projector to a computer with an RS-232C cable. This port is for control use and should not normally be used. ☛ p.132
<b>5</b>	Security slot (🔒)	The security slot compatible with the MicroSaver security system manufactured by Kensington. For more details, visit the homepage of Kensington at <a href="http://www.kensington.com/">http://www.kensington.com/</a> .
<b>6</b>	Audio Out port (EH-TW6700W/EH-TW6700/EH-TW6300 only)	Outputs audio during playback to external speakers. ☛ p.24
<b>7</b>	Cable holder	The weight of the cable may result in imperfect insertion of its connector. Put a commercially available clamping band (cable tie) through this holder to bind and fix the cable to prevent them from becoming loose.
<b>8</b>	1000 mA power supply port (EH-TW6800/EH-TW6700W/EH-TW6700 only)	Connects the power supply port for the media streaming device or optical HDMI cable.
<b>9</b>	Remote receiver	Receives signals from the remote control. ☛ p.27
<b>10</b>	USB port	Connects USB devices such as a USB memory device or a digital camera, and projects images as a slideshow. ☛ p.72 In addition, connects an optional wireless LAN unit. ☛ p.25
<b>11</b>	Service port	Service port. This is not normally used.
<b>12</b>	HDMI2/MHL port	Connects HDMI compatible video equipment and computers. ☛ p.20 Also, connects MHL compatible smartphones and tablets. ☛ p.20

Name		Function
<b>13</b>	PC port	Connects to the RGB output port on a computer. 🖱️ <a href="#">p.20</a>
<b>14</b>	HDMI1 port	Connects HDMI compatible video equipment and computers. 🖱️ <a href="#">p.20</a>
<b>15</b>	LAN port (EH-TW6800 only)	Connects a LAN cable to connect to a network. 🖱️ <a href="#">p.25</a>

## Base

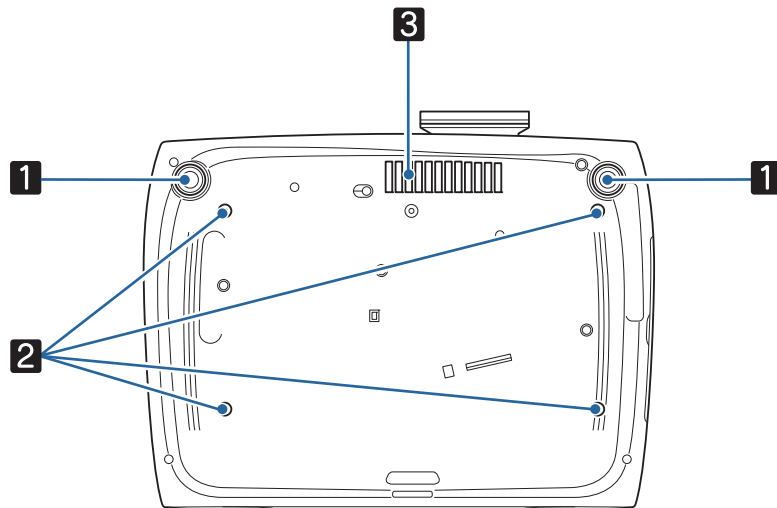

Name		Function
<b>1</b>	Front adjustable foot	When set up on a surface such as a table, extend the foot to adjust horizontal tilt. 🖱️ <a href="#">p.32</a>
<b>2</b>	Ceiling mount fixing points (four points)	Attaches the optional ceiling mount here when suspending the projector from a ceiling. 🖱️ <a href="#">p.128</a>
<b>3</b>	Air intake vent	When suspending from a ceiling, make sure it is setup so that dust does not collect in this section.

## Installing

### Projected Image and Position of Projector

Install the projector as follows.

#### Installing in parallel with the screen

If the projector is installed at an angle to the screen, keystone distortion occurs in the projected image. Adjust the projector's position so that it is installed in parallel with the screen.

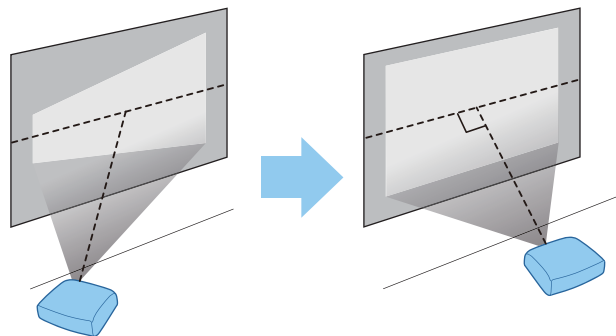

If the projector cannot be installed in front of the screen, you can adjust the position of the image by using lens shift.  [p.32](#)

#### Installing the projector horizontally by adjusting the height of either side

If the projector is tilted, the projected image is also tilted.

Install the projector horizontally so that both sides are at the same height.

If the projector cannot be installed horizontally, you can adjust the projector's tilt with the front foot.  [p.32](#)

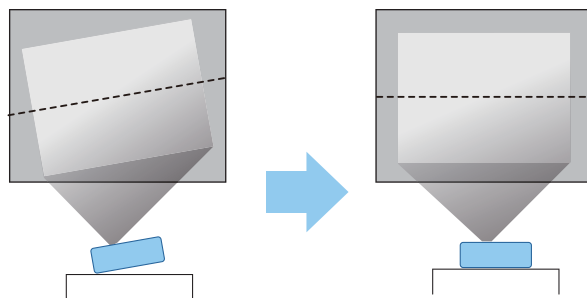

## Various Setting Methods

### Warning

- A special method of installation is required when suspending the projector from a ceiling (ceiling mount). If it is not installed correctly, it could fall causing an accident and injury.
- If you use adhesives, lubricants, or oil on the ceiling mount fixing points to prevent screws from loosening, or if you use things such as lubricants or oils on the projector, the projector case may crack causing it to fall from its ceiling mount. This could cause serious injury to anyone under the projector and also damage the projector.
- Do not install it on an unstable shelf or in a place out of load range. Otherwise, it could fall or topple causing an accident and injury.
- When installing it in a high position such as on a shelf, take measures against falling by using wires to ensure the safety in an emergency, such as an earthquake, and prevent accidents. If it is not installed correctly, it could fall causing an accident and injury.
- Do not block the air intake vent and air exhaust vent of the projector. Blocking its air intake vent and air exhaust vent may trap heat inside causing fire.

### Attention

- Do not setup the projector in locations subject to high humidity and dust, or in locations subject to smoke from fires or tobacco smoke.
- Do not use the projector installed vertically. Doing so could cause a malfunction.
- Clean the air filter once every three months. Clean it more often if the environment is particularly dusty.

 [p.116](#)

### Placing on a table and projecting

You can install the projector on a table in your living room or on a low shelf to project images.

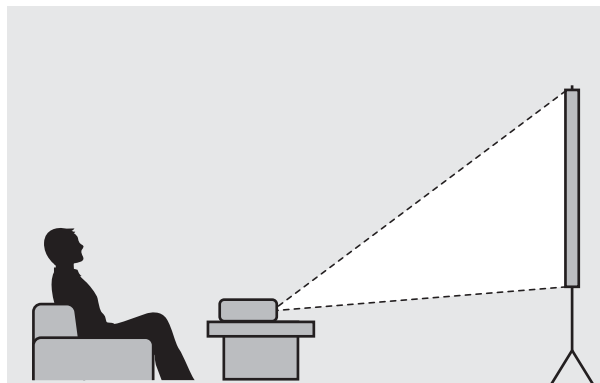

### Suspending from the ceiling and projecting

You can suspend the projector from the ceiling with the optional ceiling mount to project images.

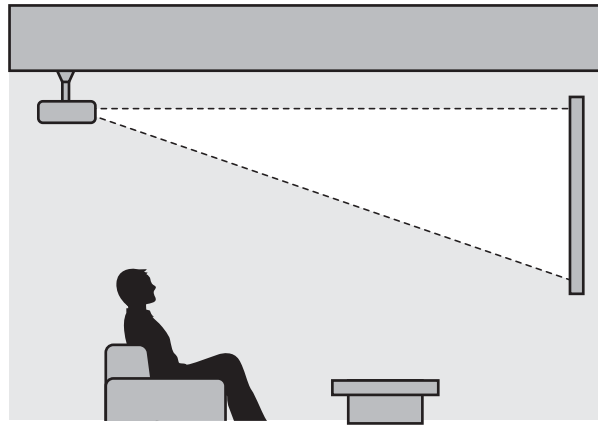

- When suspending from the ceiling and projecting, set **Projection** to **Front/Ceiling** or **Rear/Ceiling**.  
 • **Extended - Projection** p.92
- Set **Inverse Audio** to **On** to use the built-in speaker when the projector is suspended from a ceiling.  
 (EH-TW6700W/EH-TW6700 only) • **Settings - Audio - Inverse Audio** p.89

## Projection Distance and Lens Shift Maximum Values

The size of the projection increases as the projector is moved away from the screen.

Use the table below to setup the projector at the optimum position from the screen. The values given here are for your reference only.

The maximum lens shift adjustment values are shown in the following table.



The projected image becomes smaller after correcting distortion. Increase the projection distance to fit the projected image to the screen size.

When adjusting the projection position vertically in lens shift

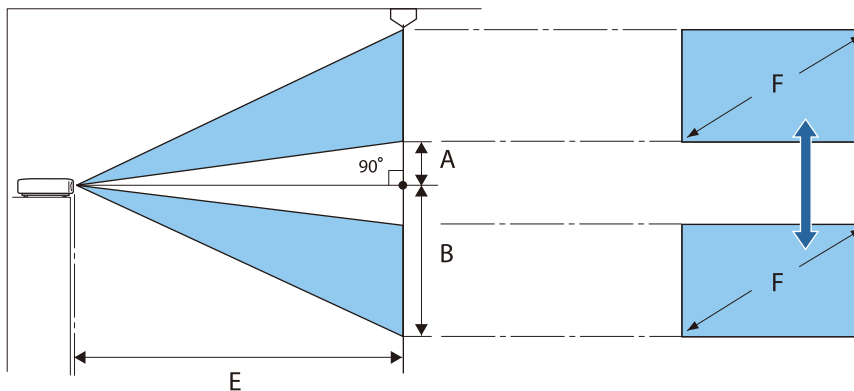

- A : Distance from the center of the lens to the bottom edge of the projected image (when lens shift is raised to its highest level)
- B : Distance from the center of the lens to the bottom edge of the projected image (when lens shift is lowered to its lowest level)
- E : Projection distance from the projector to the screen
- F : Size of the projected image

When adjusting the projection position horizontally in lens shift

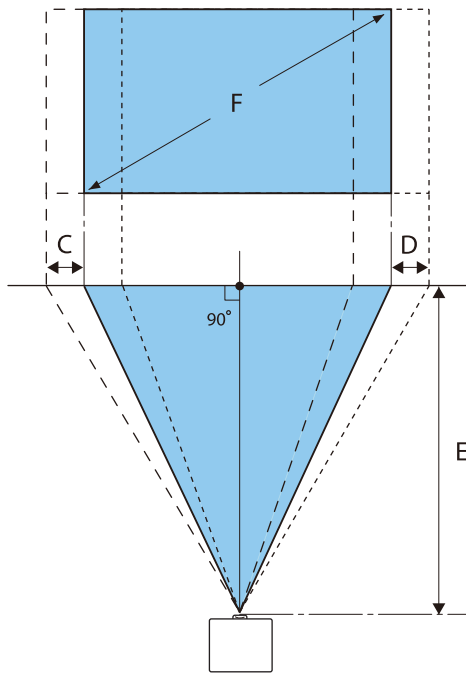

- C : Lens center movement distance when the projector is moved (when lens shift is set to maximum left)
- D : Lens center movement distance when the projector is moved (when lens shift is set to maximum right)
- E : Projection distance from the projector to the screen
- F : Size of the projected image

Unit: cm

16:9 Screen Size		Projection Distance (E)		Lens Shift Maximum Values*		
F	W x H	Minimum (Wide)	Maximum (Tele)	Distance (A)	Distance (B)	Distance (C, D)
40"	89 x 50	116	190	5	55	21
60"	130 x 75	176	286	7	82	32
80"	180 x 100	235	382	10	110	43
100"	220 x 120	295	478	12	137	53
120"	270 x 150	354	575	15	164	64
150"	330 x 190	443	719	19	205	80
180"	440 x 250	532	863	22	247	96

Unit: cm

4:3 Screen Size		Projection Distance (E)		Lens Shift Maximum Values*		
F	W x H	Minimum (Wide)	Maximum (Tele)	Distance (A)	Distance (B)	Distance (C, D)
40"	81 x 61	143	233	6	67	26
60"	120 x 90	216	351	9	101	39
80"	160 x 120	288	468	12	134	52
100"	200 x 150	361	586	15	168	65
120"	240 x 180	434	704	18	201	78

4:3 Screen Size		Projection Distance (E)		Lens Shift Maximum Values*		
F	W x H	Minimum (Wide)	Maximum (Tele)	Distance (A)	Distance (B)	Distance (C, D)
150"	300 x 230	443	719	23	251	98
200"	410 x 300	591	1175	30	335	130

\* Vertical and horizontal lens shift cannot both be set to their maximum values. [p.32](#)

### Installation example (with 16:9 screen size and 100")

Side view

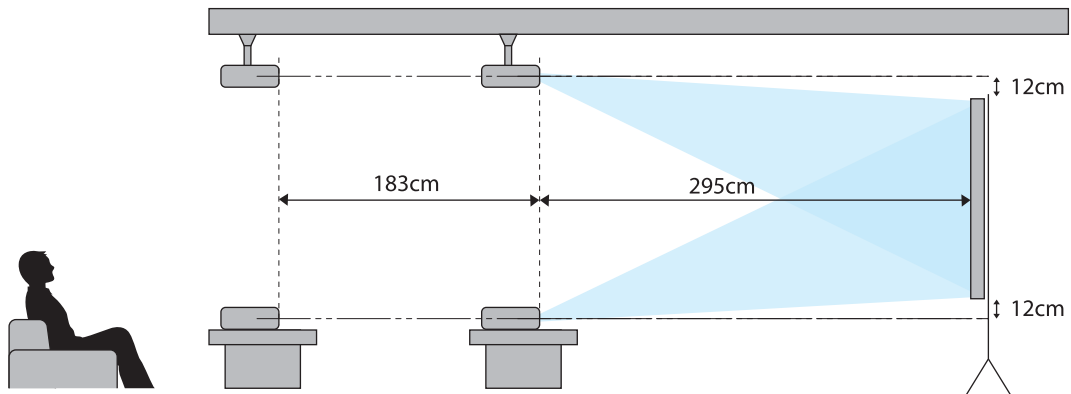

Overhead view

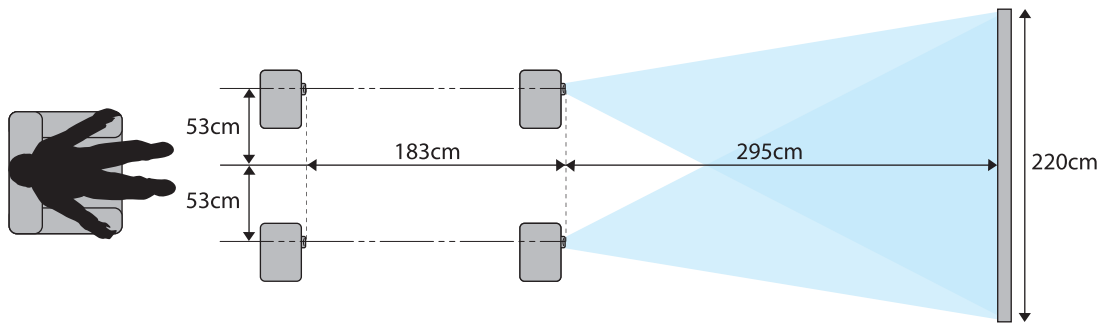



# Connecting a Device

## Attention

- Make cable connections before connecting to a power outlet.
- Check the shape of the cable's connector and the shape of the port, and then connect. If you force a connector of a different shape into the port, it could cause damage and a malfunction to occur.

EH-TW6700W comes with a terminal cover allowing you to clearly see the connector section on the rear. Remove the Terminal Cover before connecting any cables.  [p.26](#)

## Connecting Video Equipment

To project images from DVD/Blu-ray players, connect to the projector using one of the following methods.

When using a commercially available HDMI cable

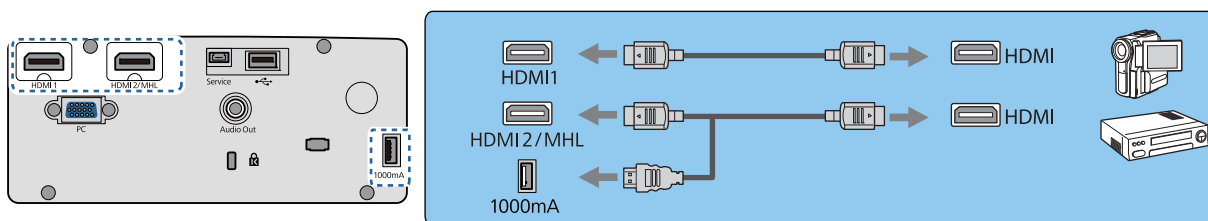

- You can also connect your AV system to enjoy the audio from connected equipment.
- When using the power supply port for an optical HDMI cable, connect it to the 1000mA power supply port. (EH-TW6800/EH-TW6700W/EH-TW6700 only)

## Connecting a Computer

To project images from a computer, connect the computer using one of the following methods.

When using a commercially available computer cable

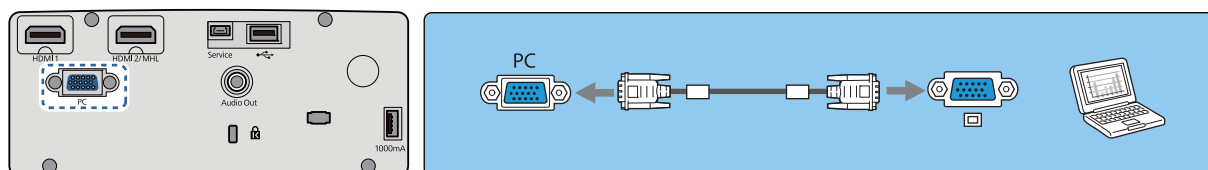

When using a commercially available HDMI cable

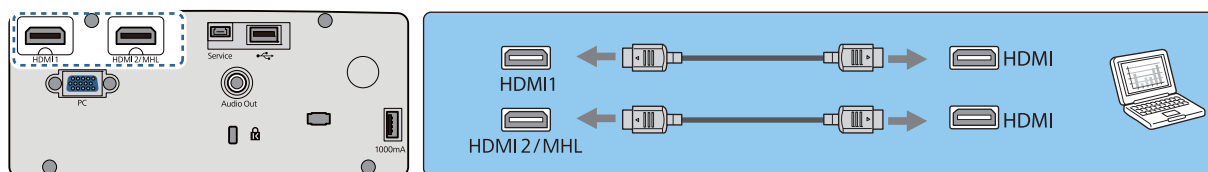

## Connecting Smartphones or Tablets

You can connect MHL compatible smartphones or tablets.

Use a commercially available MHL cable to connect the micro USB port of smartphones or tablets to the HDMI2/MHL port on the projector.

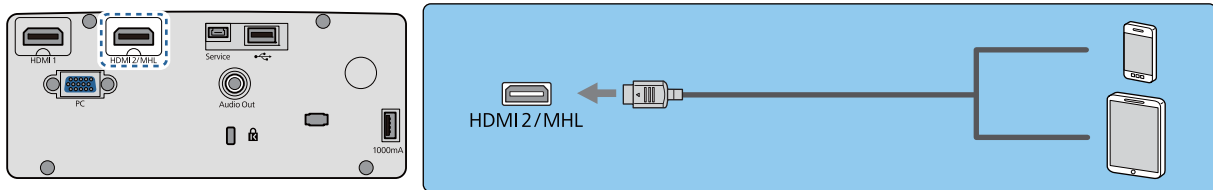

The connected smartphone or tablet begins charging when images are projected.

### Attention

- Be sure to use an MHL compatible cable for making connections. If a cable that does not meet the MHL standards is connected, the smartphone or tablet could generate heat, cause a liquid leak, explode or generate other conditions that could result in a fire.
- If you connect using a commercially available MHL-HDMI conversion adapter, charging the smartphone or tablet may not work or you may not be able to perform operations using the projector's remote control.



- When using a lot of power, such as when playing a movie, you may not be able to charge.
- This projector will not charge devices in standby mode or when the battery in a smartphone or tablet is depleted.

## Connecting USB devices

You can connect USB devices such as USB memories, and USB compatible digital cameras.

Using the USB cable supplied with the USB device, connect the USB device to the USB (TypeA) port on the projector.

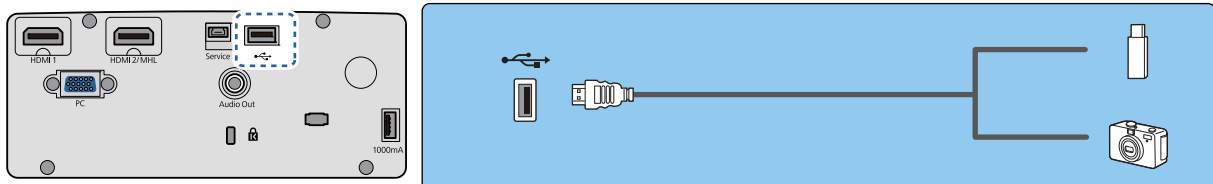

When the USB device is connected, you can project image files on the USB memory or digital camera as a slideshow. [p.72](#)

When you have finished projecting, remove USB devices from the projector. For devices with a power switch, make sure you turn them off before disconnecting the USB device.

### Attention

- If you use a USB hub, the connection may not operate correctly. Devices such as digital cameras and USB devices should be connected to the projector directly.
- Connect a digital camera using a USB cable specified for use with the device.
- Use a USB cable less than 3 m in length. If the cable exceeds 3 m, slideshows may not function correctly.

## Connecting External Equipment

### Connecting Bluetooth® devices

You can connect audio devices that support Bluetooth (A2DP compliant) or 3D Glasses (Bluetooth 3DS Profile compliant).



Bluetooth audio devices are not supported in some countries and regions.

See the following for information on connecting 3D Glasses.

☛ "Pairing 3D Glasses" p.51

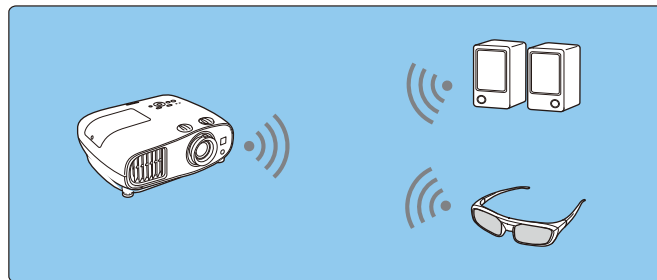



Audio input to the HDMI1 port or HDMI2/MHL port is output from speakers or headphones that support Bluetooth.

1 Press the  button to display menus in the order **Settings - HDMI Link - Audio Out Device**.

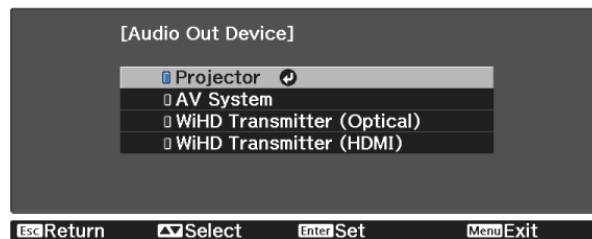

2 Use the   buttons to select **Projector**, and then press the  button to confirm the selection.



3 Display menus in the order **Settings - Bluetooth - Bluetooth Audio**.

4 Use the   buttons to select **On**, and then press the  button to confirm the selection.



- 5 Turn on "pairing mode" on the Bluetooth device you want to connect to.  
See the documentation supplied with the Bluetooth device for more information.
- 6 Select **Search Bluetooth Device**.  
A list of available devices is displayed.
- 7 Use the   buttons to select the Bluetooth device you want to connect to, and then press the  button to connect.

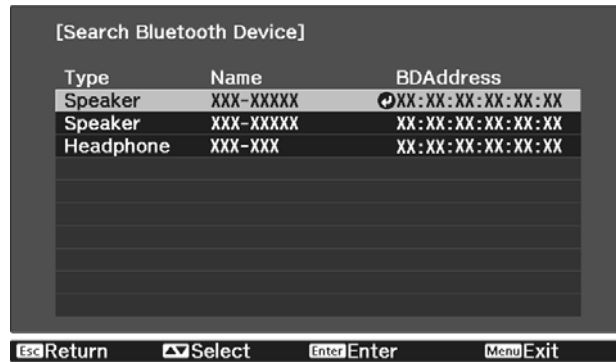

The next time you turn on the projector, it automatically connects to the last device it connected to. To change the connected device, repeat the procedure from step 5.

#### Bluetooth specifications

Version	Bluetooth Ver. 3.0
Output	Class 2
Communication distance	Approx. 10 m
Supported profiles	A2DP
Content protection	SCMS-T
Frequency used	2.4 GHz band (2.402 to 2.480 GHz)
Supported codecs	SBC, Qualcomm® aptX™ audio

#### Warning

- Electromagnetic interference may cause medical equipment to malfunction. Before using the device, make sure there is no medical equipment in the vicinity.
- Electromagnetic interference may cause automatically controlled equipment to malfunction which could cause an accident. Do not use the device near automatically controlled equipment such as automatic doors or fire alarms.



- Connect a Bluetooth device that supports copyright protection (SCMS-T).
- You may not be able to connect depending on the standard and type of device.
- Even when connecting within the specified communication distance, connections can be lost due to the status of the signal.
- The communication method for Bluetooth uses the same frequency (2.4 GHz) as wireless LAN (IEEE802.11b/g) or microwave ovens. Therefore, if these devices are used at the same time, radio wave interference may occur, the image and audio may be interrupted, or communication may not be possible. If you do need to use these devices at the same time, make sure there is enough distance between them and the Bluetooth device.
- You cannot connect multiple Bluetooth devices to the projector at the same time.
- There is a delay in the audio output from any Bluetooth audio devices.

## Connecting external speakers (EH-TW6700W/EH-TW6700/EH-TW6300 only)

To output audio from external speakers, connect the speakers to the projector's Audio Out port with a commercially available audio cable.

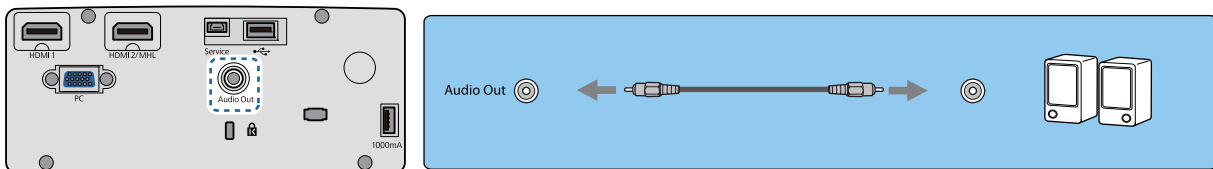

- To output audio from external speakers, set **Audio Out Device** to **Projector**. **Settings - HDMI Link - Audio Out Device** [p.89](#)
- When an AV system is not connected to the projector, audio is output from the external speakers, even if **Audio Out Device** is set to **AV System**.

## Connecting WirelessHD devices (EH-TW6700W only)

The projector receives transmissions from the WirelessHD Transmitter, and projects the images. [p.56](#)  
Switch the projected image by pressing the **WirelessHD** button on the remote control.



- When receiving WirelessHD images, make sure **WirelessHD** is set to **On**. **Settings - WirelessHD - WirelessHD** [p.89](#)
- You can change which device is displayed by selecting a device from **Device Connections** in **HDMI Link**. **Settings - HDMI Link - Device Connections** [p.89](#)

## Connecting Smartphones or Tablets

You can connect MHL compatible smartphones or tablets to the WirelessHD Transmitter. Use an MHL compatible cable to connect the micro USB port of smartphones and tablets to the HDMI4 port on the WirelessHD Transmitter.

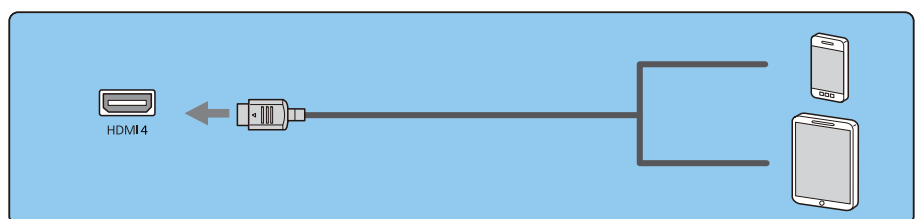
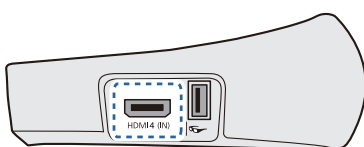

You can operate smartphones or tablets from the projector remote control. You can also view video and listen to music while charging a smartphone or tablet.

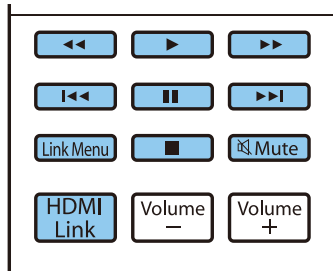

**Attention**

- Make sure the connection cable supports the MHL standards. During charging, the smartphone or tablet could generate heat, cause a liquid leak, explode or generate other conditions that could result in a fire.
- When a connection is made using an MHL-HDMI conversion adapter, it may not be possible to charge or control the device from the remote control.



Some devices use more power during video playback than what is supplied and will therefore not enable charging during video playback or other operations.

**Connecting to the Trigger Out port (EH-TW6800 only)**

To connect external devices such as motorized screens, connect a mini-jack stereo cable (3.5 mm) to the Trigger Out port. When set to on, a signal (12 V DC) is output from this port to communicate the projector's status (On or Off) to connected devices such as electric screens.



When using the **Trigger Out** port, set the **Trigger Out** function to **Power**.  
 ➔ **Extended - Operation - Trigger Out** [p.92](#)

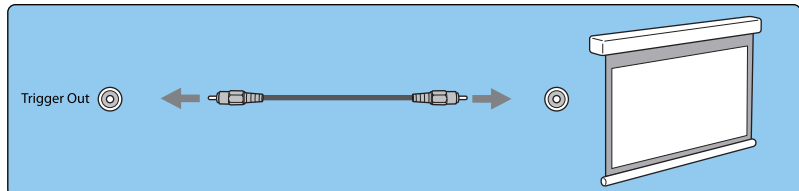
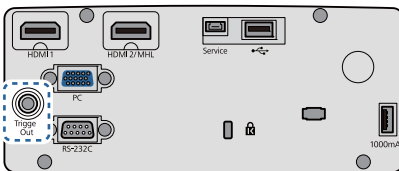

**Connecting to the LAN port (EH-TW6800 only)**

Connect to a network router, a hub, and so on, with a 100BASE-TX or 10BASE-T LAN cable. You can operate the projector or check its status over a network from a computer or a smart device.

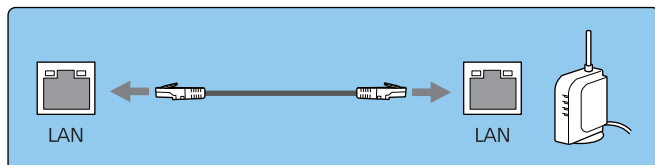
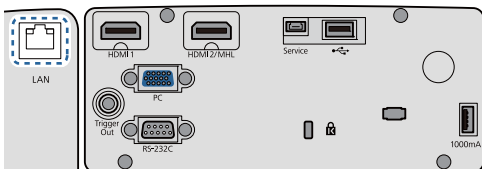

To prevent malfunctions, use a category 5 or higher shielded LAN cable.

## Attaching the Wireless LAN unit

To use the wireless LAN function, attach an optional Wireless LAN unit (ELPAP10).  
Connect the Wireless LAN unit to the USB port.

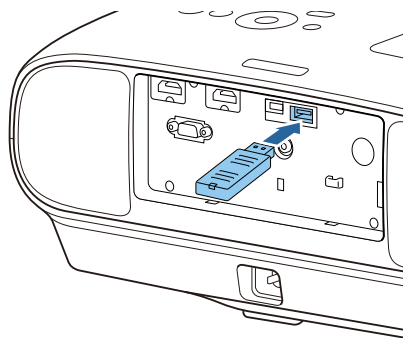

You can use one of the following methods to project over wireless LAN. For more details, see the download page.

- **Projecting four screens simultaneously**

When using EasyMP Multi PC Projection, you can project up to four separate screens from up to 50 computers connected to the network.

Download EasyMP Multi PC Projection from the following Web site.

<http://www.epson.com>

- **Projecting images from a mobile terminal via a network**

By installing "Epson iProjection" on a smartphone or tablet, you can wirelessly project data on your device. p.81



- When not using the wireless LAN function with the Wireless LAN unit kept inserted, set **Wireless LAN Power** to **Off**. This can prevent unauthorized access from outsiders. p.95
- When using Epson iProjection or EasyMP Multi PC Projection in **Quick**, we recommend making security settings. p.98

## Removing the Terminal Cover

The terminal cover is attached to the connector section on the rear of EH-TW6700W. Remove this cover when using a cable to connect a device.

There are gaps at the bottom of the terminal cover that allows you to pull the cover forward and lift it from the grooves at the top.

When reattaching, first insert the protruding sections into the grooves at the top.

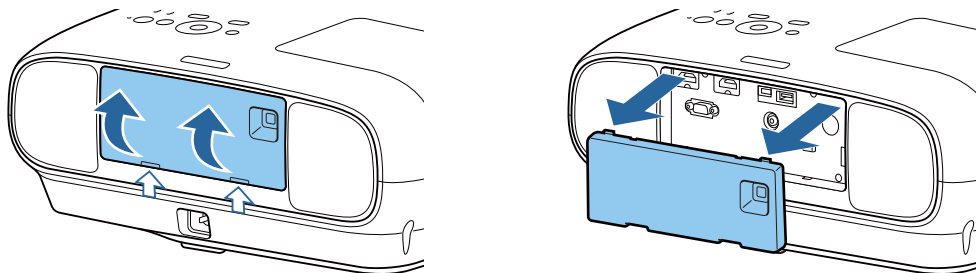



# Preparing the Remote Control

## Installing the Remote Control Batteries

### Attention

- Check the positions of the (+) and (-) marks inside the battery holder to ensure the batteries are inserted the correct way.
- You cannot use other batteries except for the AA size manganese or alkaline.

- 1** Remove the battery cover.  
While pushing the battery compartment cover catch, lift the cover up.

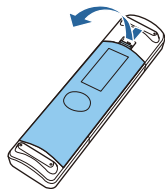

- 2** Replace the old batteries with new batteries.  
Check the polarity of the batteries (+) and (-) before installing.

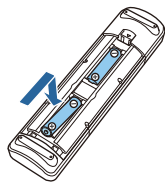

- 3** Reattach the battery cover.  
Press the cover until it clicks into place.

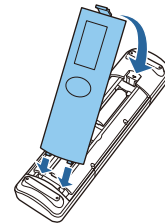

If delays in the responsiveness of the remote control occur or if it does not operate, it probably means that the batteries are becoming flat. When this happens, replace them with new batteries. Have two AA size manganese or alkaline batteries ready.

## Remote Control Operating Range

The operation range for the WirelessHD Transmitter differs. [p.67](#)

### Operating range (left to right)

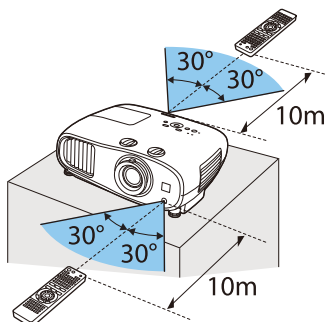

### Operating range (top to bottom)

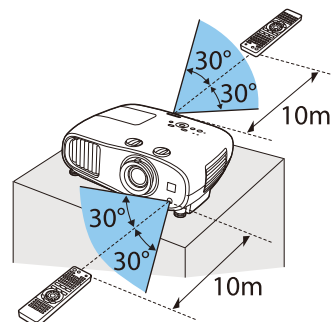



# Projecting Images

## Turning On the Projector

1 Connect the equipment to the projector.

2 Connect using the power cord supplied.

3 Remove the lens cap.

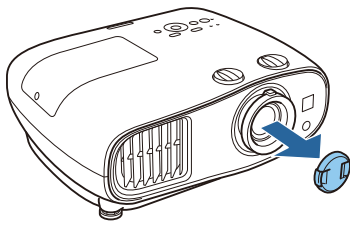

4 Turn on the connected equipment.

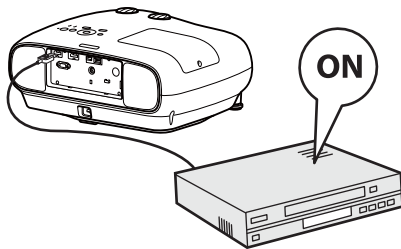

5 Press the button on the remote control or the button on the control panel to turn on the projector.

Remote control

Control panel

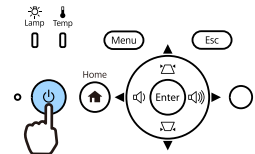
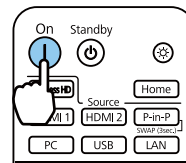

The projector's operation indicator flashes blue as the projector warms up. Once the projector is warmed up, the power indicator and the operation indicator turn blue.

When **Direct Power On** is set to **On**, you can start projecting by simply connecting the power cord to the projector without having to press any buttons. **Extended - Operation - Direct Power On** [p.92](#)

**Warning**

- Do not look into the lens during projection. The powerful light emitted could cause damage to eyesight.
- Do not stand in front of the lens during projection. Clothes could be damaged due to the high temperature.

This projector provides a Child Lock function to prevent children from accidentally turning the power on and a Control Panel Lock function to prevent accidental operations and so on. **Settings - Lock Setting - Child Lock/Control Panel Lock** [p.89](#)

- This projector provides an Auto Setup function to automatically select the optimum settings when the input signal for the connected computer image changes. **Signal - Auto Setup** [p.88](#)
- When using at an altitude of 1500 m or more, set **High Altitude Mode** to **On**. **Extended - Operation - High Altitude Mode** [p.92](#)

If the target image is not projected

If the image is not projected, you can change the source using one of the following methods.

Remote control

Press the button for the target port.

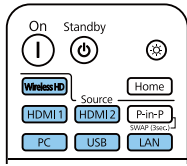

Control panel

Press the  button, and then select the target input device on the home screen displayed.

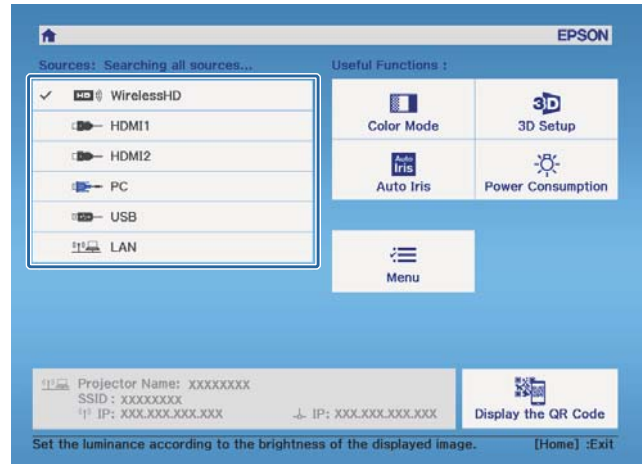

Using the Home Screen





The Home screen feature allows you to easily select an image source and access useful functions.

Press the  button on the remote control or the  button on the control panel to display the Home screen.

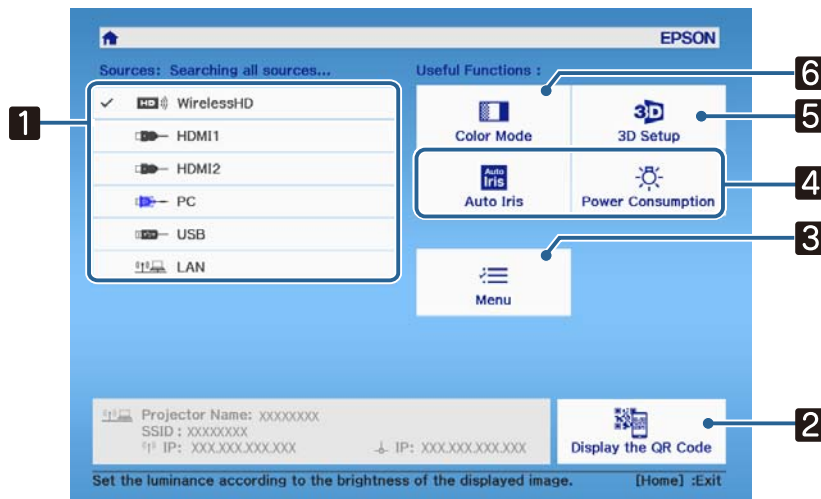
Under the following conditions, the Home screen is displayed automatically when the projector is turned on.

- **Home Screen Auto Disp.** is set to **On**.  **Extended - Home Screen - Home Screen Auto Disp.** p.92
- There are no signals from any sources.



<b>1</b>	Selects the source you want to project.
<b>2</b>	Displays the QR code and connects wirelessly to a smartphone or tablet.  p.81
<b>3</b>	Displays the Configuration menu.  p.85
<b>4</b>	Performs menu options assigned to <b>Home Screen</b> in the <b>Extended</b> menu.  <b>Extended - Home Screen</b> p.92
<b>5</b>	Sets the 3D function.  <b>Video - 3D Setup</b> p.88
<b>6</b>	Selects the <b>Color Mode</b> .  p.37



The Home screen disappears after 10 minutes of inactivity.

## Turning Off

**1** Turn off the connected equipment.

**2** Press the button on the remote control or the control panel.

Remote control

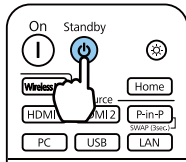

Control panel

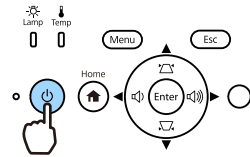

A confirmation message is displayed.

**3** Press the button again.

Power Off?

Yes : Press button  
No : Press any other button

The operation indicator flashes and the projector begins to cool down.



When **Standby Confirmation** is set to **Off**, you can turn off the projector by pressing the button on the remote control once. **Extended - Display - Standby Confirmation** p.92

**4** Wait until cool-down is complete.

When cool-down is complete, the operation indicator stops flashing.

**5** Disconnect the power cord.



- If the power cord is connected, some electricity is consumed even if no operations are made.
- When connecting the power cord again, wait a sufficient time interval.

**6** Attach the lens cap.

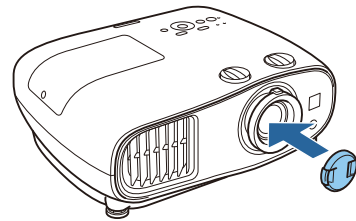



## Adjusting the Projected Image



Since images are unstable immediately after the projector is turned on, before you make focus, zoom, or lens shift settings, we recommend waiting 30 minutes or more after starting to project the images.

### Displaying the Test Pattern

When adjusting the zoom/focus or the projection position just after setting up the projector, you can display a test pattern instead of connecting video equipment.

Press the **Pattern** button on the remote control to display the test pattern. The standard for horizontal lines at the top and bottom uses 2.40:1 CinemaScope.

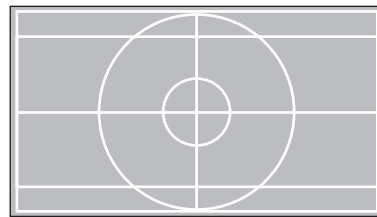
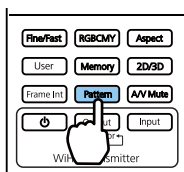

When you select Color Isolation while projecting images, the color selected from R (red), G (green), or B (blue) is projected. (EH-TW6800 only)

Press the **Pattern** button again to end the test pattern display.

### Adjusting the Focus

Turn the focus ring to adjust the focus.

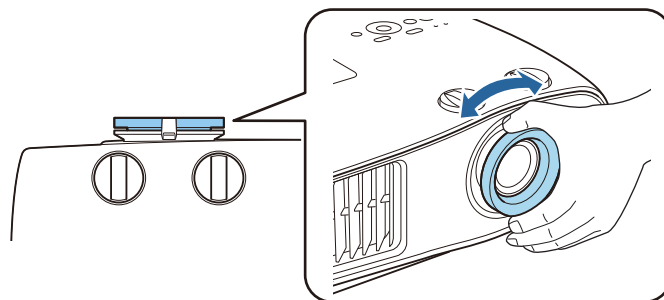

### Adjusting the Projection Size (Adjust Zoom)

Grip the knob and turn the zoom ring to adjust the size of the projected image.

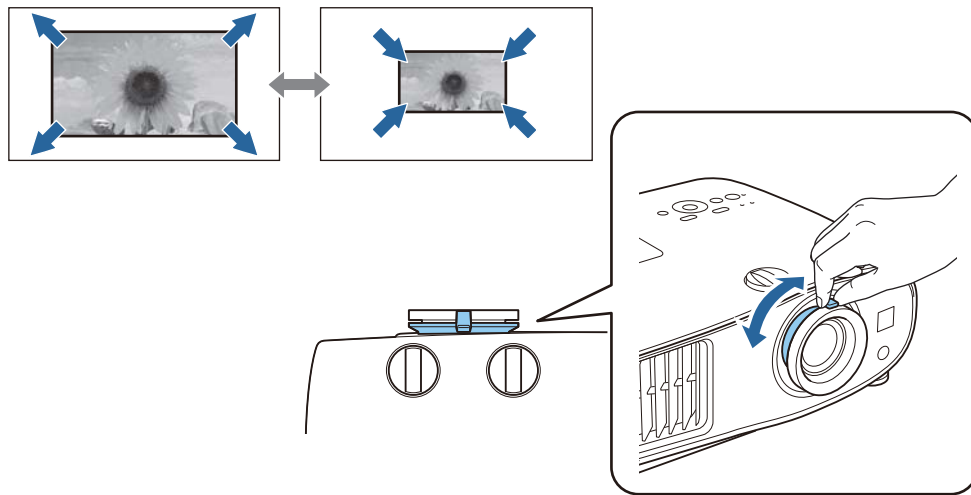

### Adjusting the Projector's Tilt

If the projected image is horizontally tilted (the left and right sides of the projected image are at different heights) when the projector is setup on a table, adjust the front foot so that both sides are level with each other.

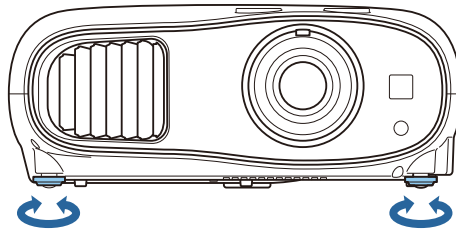

### Adjusting the Position of the Image (Lens Shift)

If the projector cannot be installed directly in front of the screen, you can adjust the position of the image by using lens shift.

Turn the vertical and horizontal lens shift dials on the projector to adjust the position of the image. To locate the center of the lens shift range, turn the lens shift dial until you hear it click.

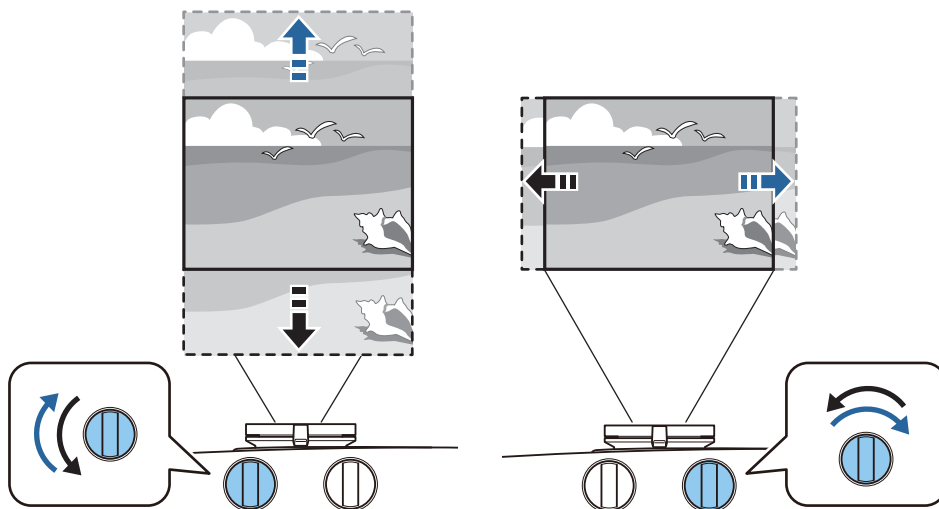

### Attention

- When using vertical lens shift for adjusting the position of the image, adjust the image by moving it upward and then finish the adjustment. If you move the image downward and finish the adjustment, its position may lower slightly.
- Do not keep turning the lens shift dials without effect. Once the projection image is positioned all the way to one edge, turning the dial further may impair image quality.



- The sharpest images will be achieved when both of the vertical and horizontal lens shift dials are centered.
- When adjusting the projection position using the lens shift, you are recommended to install the projector in parallel with the screen.

You can move the image within the following range.

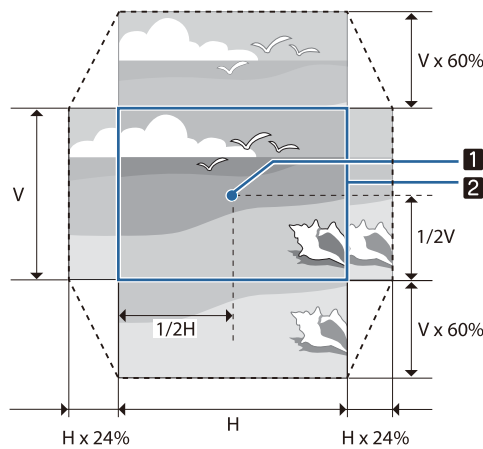

- 1 Center of the lens
- 2 Image with lens shift centered



### Caution

When transporting the projector, set the lens position to the center. If you transport the projector when the lens is not in the central position, the lens shift mechanism could be damaged. Also, attach the protective pad that was attached when you purchased it.



When you cannot make adjustments using lens shift, use Keystone to correct the distortion. [p.33](#)

## Correcting Keystone Distortion

If you place the projector at an angle to the screen, or tilt it up or down, or off to the side, you may need to correct the distortion in the image.

You can correct it by using one of the following two methods.

- Manually correct horizontal and vertical directions [p.34](#)
- Correct the corners of the projected image individually [p.34](#)



Before correcting keystone distortion, it is recommended that you rotate the lens shift dials to adjust the lens position as shown below:

- Horizontal position of lens: Center
- Vertical position of lens: Top edge

## ■ Correcting using the Keystone button

You can use the (or the ) buttons on the control panel to correct keystone distortion. Press the buttons to display the V-Keystone/H-Keystone gauges.

When the gauges are displayed, press the buttons to perform vertical correction, and press the (or ) buttons to perform horizontal correction.

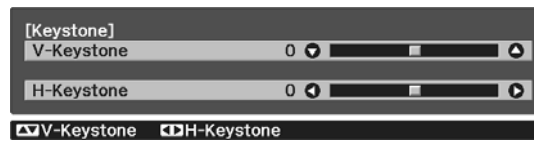

### When the top or bottom is too wide

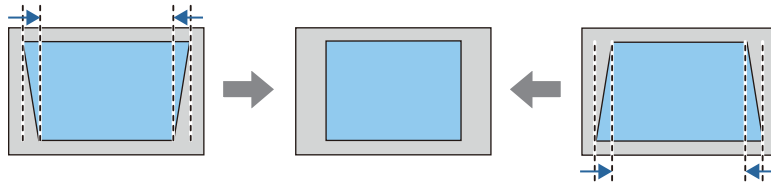
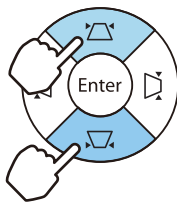

### When the left or right is too wide

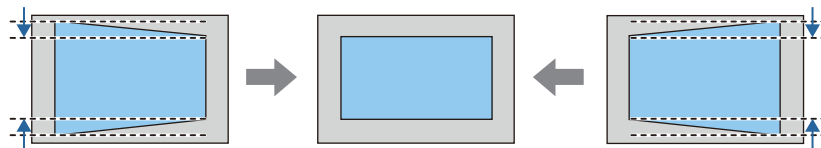
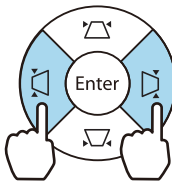

- When you correct keystone distortion, the projected image may be reduced. Increase the projection distance to fit the projected image to the screen size.
- You can also set H/V-Keystone from the Configuration menu. **Settings - Keystone - H/V-Keystone** [p.89](#)
- You can make effective corrections within a projection angle range of 30° in any direction.
- You can adjust the volume by pressing the buttons when the V-Keystone/H-Keystone gauges are not displayed. (EH-TW6700W/EH-TW6700 only) [p.35](#)

## ■ Correcting with Quick Corner

You can use the projector's Quick Corner setting to correct the shape and size of an image that is unevenly rectangular.



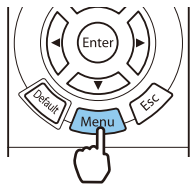

- 1 Press the  button to display menus in the order **Settings - Keystone**.

Remote control

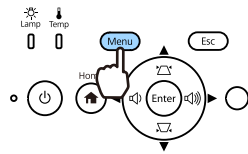





Control panel

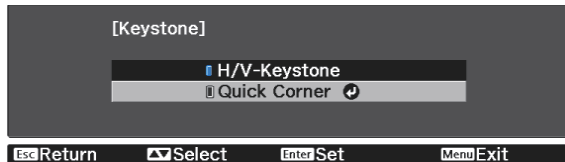



- 2 Use the   button to select **Quick Corner**, and then press the  button. Press the  button again if necessary.





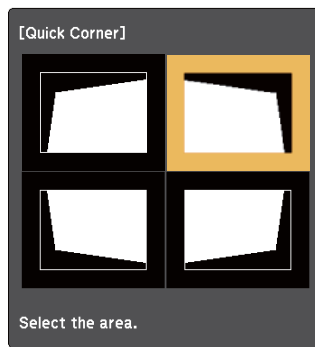

The area selection screen is displayed.

- 3 Use the     buttons to select the corner of the image you want to adjust. Then press the  button.



To reset the Quick Corner corrections, hold down the  button for about two seconds while the area selection screen is displayed, and then select **Yes**.

- 4 Press the    buttons to adjust the image shape as necessary. Press the  button to return to the area selection screen.



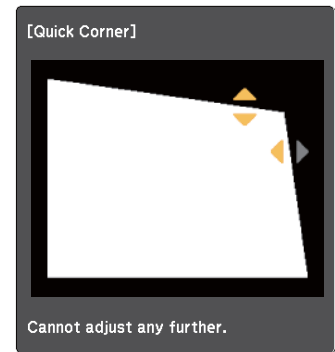

If you see this screen, you cannot adjust the shape any further in the direction indicated by the gray triangle.







- 5 Repeat steps 3 and 4 as needed to adjust any remaining corners.

- 6 When you are finished, press the  button.



After executing Quick Corner, the **Keystone** setting is now set to **Quick Corner** in the projector's **Settings** menu. When you press one of the   buttons on the control panel, the area selection screen is displayed.

## Adjusting the Volume

You can control the volume using the   buttons on the remote control, or the   buttons on the control panel (EH-TW6700W/EH-TW6700 only).



Remote control

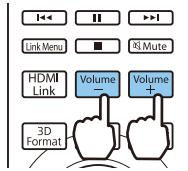

Control panel

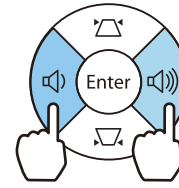

- You can also adjust the volume from the Configuration menu. 🖱️ **Settings - Audio - Volume** p.89
- When an AV System is connected to the projector and you want to adjust the volume for the AV system, set **HDMI Link** to **On** and **Audio Out Device** to **AV System**. 🖱️ **Settings - HDMI Link** p.89
- You cannot adjust the volume of Bluetooth audio devices from the projector.



Caution

Do not start at high volume.

A sudden excessive volume may cause loss of hearing. Always lower the volume before powering off, so that you can power on and then gradually increase the volume.

Hiding the Image and Muting the Audio Temporarily (A/V Mute)

Press the **A/V Mute** button to show or hide the image. The audio is also muted or played.

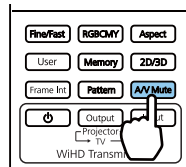

- For movies, the image and audio continue to play even during A/V Mute. You cannot resume from the point that you muted the video and audio using the **A/V Mute** button.
- To mute or play only the audio, press the **Mute** button.
- When outputting audio from an AV system and you want to adjust the volume for the AV system, set **HDMI Link** to **On** and **Audio Out Device** to **AV System**. 🖱️ **Settings - HDMI Link** p.89





# Adjusting the Image

## Selecting the Projection Quality (Color Mode)

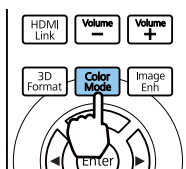

You can obtain the optimum image quality to suit your surroundings when projecting. The brightness of the image varies depending on the mode selected.

**1** Press the  button.



-  You can make settings from the Configuration menu.  **Image - Color Mode** [p.86](#)
- If you press the  button, you can also make settings from the Home screen.  [p.29](#)

**2** Select **Color Mode**.

Use the   buttons to select a mode, and then press the  button to confirm the selection.

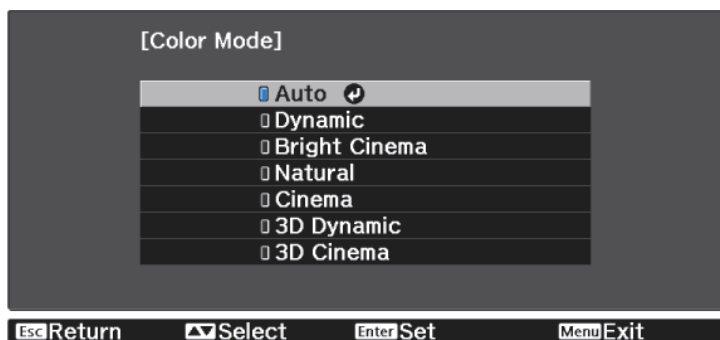

### Choices when projecting 2D images

Mode	Application
Auto*	Sets the color mode automatically according to the surroundings.
Dynamic	This is the brightest mode. Best for prioritizing brightness.
Bright Cinema	Best for projecting vivid images.
Natural	Best for faithfully reproducing the color of the source image. We recommend selecting this mode when performing color adjustment for the image.  <a href="#">p.43</a>
Cinema	Best for enjoying content such as movies.

\* This can only be set when **Projection** is set to **Front**.  [p.92](#)

### Choices when projecting 3D images

Mode	Application
3D Dynamic	A dedicated 3D mode best for prioritizing brightness.
3D Cinema	A dedicated 3D mode best for enjoying content such as movies.

## Switching the Screen Between Full and Zoom (Aspect)

You can change the input signal's type, aspect ratio, and resolution to match the **Aspect** of the projected image.



The available settings vary depending on the image signal currently being projected.

 Note that using the aspect ratio function of the projector to reduce, enlarge, or split the projected image for commercial purposes or for public viewing may infringe upon the rights of the copyright holder of that image based on copyright law.

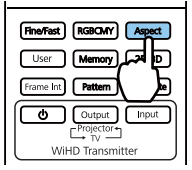
**1** Press the Aspect button.



 You can make settings from the Configuration menu. **Signal - Aspect p.88**

**2** Use the   buttons to select the setting name, and then press the Enter button to confirm the selection.

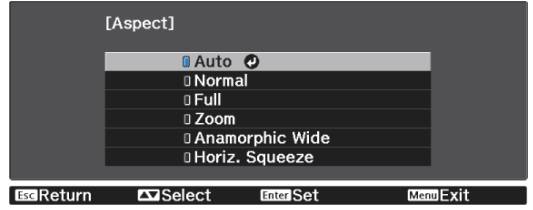

 You may not be able to change the **Aspect** depending on the input signal.

By normally selecting **Auto**, the optimum aspect is used to display the input signal. Change the setting if you want to use a different aspect.

The table below shows the image projected on a 16:9 screen.

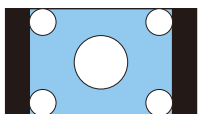
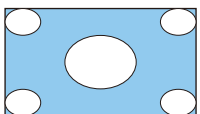
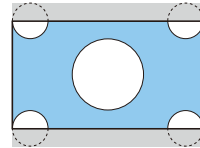
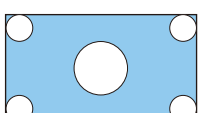
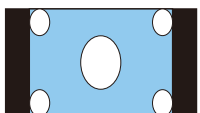
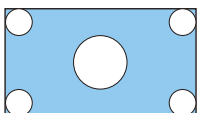
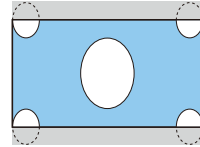
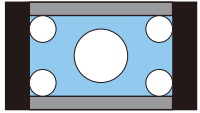
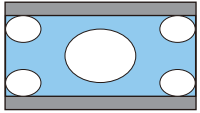
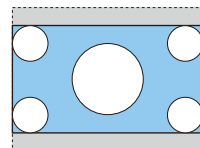
Input Image	Setting Name		
	Normal	Full	Zoom
4:3 Images			
16:9 Images		When projecting 16:9 images, Full and Zoom cannot be selected.	
Images Recorded Using Squeeze			
Letterbox Images*			

Input Image	Setting Name		
	Normal	Full	Zoom
Notes	Matches the vertical size of the projection panel. The aspect ratio differs depending on the input image.	Uses the entire projection panel. The aspect ratio differs depending on the input resolution.	Retains the aspect ratio of the input signal, and matches the horizontal size of the projection panel. The top and bottom of the image may be truncated.

\* The letterbox image used in this explanation is a 4:3 aspect ratio image displayed in 16:9 with black margins at the top and bottom for subtitle placement. The margins at the top and bottom of the screen image are used for subtitles.

For EH-TW6800, you can also set **Anamorphic Wide** and **Horiz. Squeeze**.

Set **Anamorphic Wide** and attach a commercially available anamorphic lens to enjoy DVDs, Blu-rays, and so on of images recorded at Cinema Scope size.

**Horiz. Squeeze** stretches the horizontal aspect of the input signal. This allows you to project across the full width of the screen when using a commercially available anamorphic lens.



- If **Anamorphic Wide** is selected when **Overscan** is set, the image may be truncated. Set **Overscan** to **Off**. **Signal - Overscan** p.88
- When projecting 3D images in **Anamorphic Wide**, only 1080p/24 Hz/frame packing signals are supported.

## Adjusting the Sharpness

You can make the image clearer.

The following shows the setting items and procedures.

Standard	Enhances the outlines for the projected image overall. When adjusting <b>Standard</b> , the adjustment values for <b>Thin Line Enhancement</b> and <b>Thick Line Enhancement</b> are also adjusted at the same time.
Thin Line Enhancement	Details such as hair and patterns on clothing are enhanced.
Thick Line Enhancement	Rough parts such as outlines for entire subjects or the background are enhanced, making the overall image clearer.

1 Press the button.

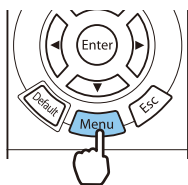

The Configuration menu is displayed.

2 Select **Image - Sharpness**.

The **Sharpness** adjustment screen is displayed.

3 Use the buttons to select the item, and then use the buttons to make the adjustments.

The image is enhanced when moved to the right (positive) and softer when moved to the left (negative).

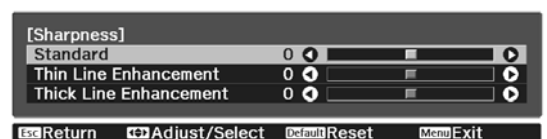

Press the button to return the adjustments to their default values.

- Press the  button to exit the menu.



## Adjusting Image Resolution (Image Enhancement)

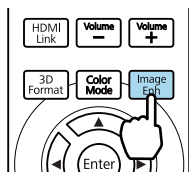

You can adjust the resolution of the image using the Image Enhancement function. The following content can be adjusted.

Image Preset Mode	Select the settings prepared in advance as the settings for <b>Noise Reduction</b> , <b>MPEG Noise Reduction</b> , <b>Super-resolution</b> , and <b>Detail Enhancement</b> .
Noise Reduction	(This can only be set when <b>Image Processing</b> is set to <b>Fine</b> .) Smoothes out rough images.
MPEG Noise Reduction	(This can only be set when <b>Image Processing</b> is set to <b>Fine</b> .) You can reduce dot and block noise that occurs in outlines when projecting MPEG movies.
Super-resolution	Fine Line Adjust: Enhances the contrast and the outlines of complicated images. Soft Focus Detail: Enhances the contrast and the outlines for smooth backgrounds.
Detail Enhancement	Enhances the contrast in an image to create a more emphatic texture and material feel. Depending on the image, a highlight may be noticeable at the border between colors. If this bothers you, set a smaller value. For the EH-TW6800, you can set <b>Strength</b> and <b>Range</b> . <b>Strength</b> : The larger the value, the stronger the contrast. <b>Range</b> : The larger the value, the wider the range of detail enhancement becomes.

- Press the  button.



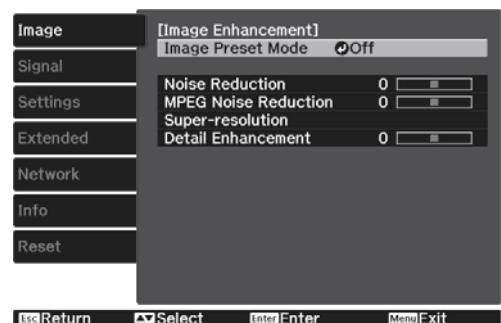

 You can make settings from the Configuration menu.  **Image - Image Enhancement** p.86

- Use the   buttons to select the item you want to adjust, and then press the  button to confirm the selection.



3 Use the  buttons to make adjustments.

Press the  button to adjust another item.

Press the  button to return the adjustments to their default values.





4 Press the  button to exit the menu.

## Setting Auto Iris

By automatically setting the luminance according to the displayed image, you can enjoy deep and rich images. You can select the luminance adjustment tracking for changes in brightness in the displayed image from **Normal** to **High Speed**.

Press the  button to display menus in the following order.

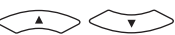
### Image - Auto Iris

Use the  buttons to select the item, and then press the  button to confirm the selection.

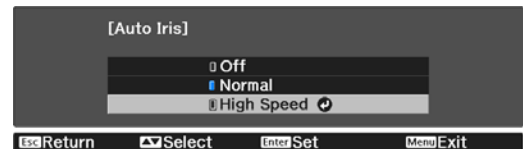



Depending on the image, you may hear the Auto Iris operating, but this is not a malfunction.

## Setting Frame Interpolation

You can play fast moving images smoothly by automatically producing intermediate frames between the original frames.



Frame Interpolation is available under the following conditions.

- When **Image Processing** is set to **Fine**.  **Signal - Advanced - Image Processing** p.88
- When the source is HDMI1, HDMI2, or WirelessHD.
- When inputting 2D signals or 3D signals (1080p 24 Hz).  p.129

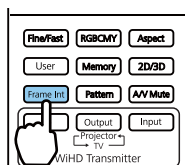
1 Press the  button.

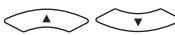

You can make settings from the Configuration menu.  **Image - Frame Interpolation** p.86

2 Use the  buttons to select the item, and then press the  button to confirm the selection.

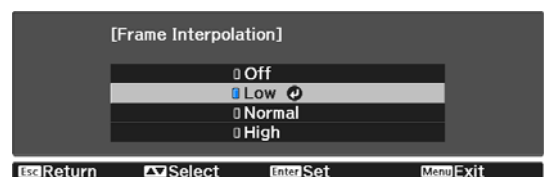



### Setting the Image Processing Speed

Improves the response speed for images projected at high-speed, such as games.

This is only available when receiving a progressive signal input from the HDMI1 or HDMI2 ports, or from WirelessHD.

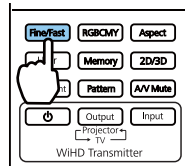
Press the  button to switch **Fine** and **Fast**.



- You can make settings from the Configuration menu.  **Signal - Advanced - Image Processing** [p.88](#)
- This does not support 3D images.
- When **Image Processing** is set to **Fast**, **Noise Reduction**, **MPEG Noise Reduction**, and **2D-to-3D Conversion** are fixed at Off.



# Adjusting the Color

## Adjusting the Color Temp.

You can adjust the overall tint of the image. Make adjustments if the image is a little too blue or too red and so on.

Press the  button to display menus in the following order.

**Image - Color Temp. - Color Temp.**

Use the   buttons to make adjustments.

Blue tints grow stronger as the value is increased, and red tints grow stronger as the value is reduced.







Press the  button to return the adjustments to their default values.

## Adjusting the RGB (Offset and Gain)

You can adjust the brightness of dark areas (Offset) and bright areas (Gain) for R (red), G (green), and B (blue).

Press the  button to display menus in the following order.

**Image - Color Temp. - Customized**

Use the   buttons to select the item, and then use the   buttons to make the adjustments. The image becomes brighter when moved to the right (positive) and darker when moved to the left (negative).



Offset	When the image is made brighter, shading for the darker sections is more vividly expressed. When the image is made darker, the image appears more full-bodied but shading for the darker sections is harder to distinguish.
Gain	When the image is made brighter, the bright sections become whiter and shading is lost. When the image is made darker, shading for the bright sections is more vividly expressed.



Press the  button to return the adjustments to their default values.

## Adjusting Hue, Saturation, and Brightness

You can adjust the hue, saturation, and brightness for each of the R (red), G (green), B (blue), C (cyan), M (magenta), and Y (yellow) colors.

Hue	Adjusts the overall color of the image to be blue, green, or red.
Saturation	Adjusts the overall vividness of the image.
Brightness	Adjusts the overall color brightness of the image.



1 Press the **RGBCMY** button.

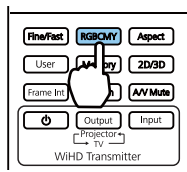

You can make settings from the Configuration menu. **Image - Advanced - RGBCMY** [p.86](#)

2 Use the buttons to select the color you want to adjust, and then press the button to confirm the selection.

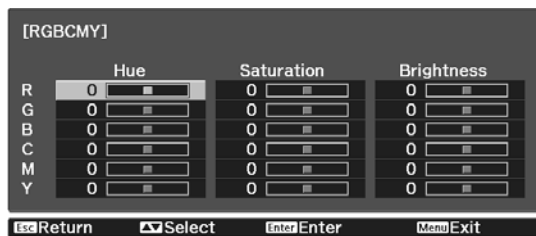

3 Use the buttons to select **Hue, Saturation, or Brightness.**

4 Use the buttons to make adjustments.

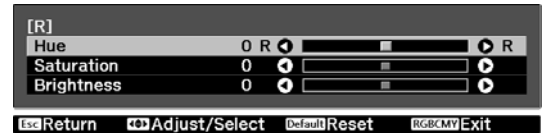

Press the button to adjust another color.

Press the button to return the adjustments to their default values.

5 Press the **RGBCMY** button to exit the menu.

## Adjusting the Gamma

You can adjust slight coloration differences that may occur due to the device being used when the image is displayed.

You can set it by using one of the following three methods.



- Select and adjust the correction value
- Adjust while viewing the image
- Adjust using the gamma adjustment graph



When a 3D signal or HDR signal is being input, you cannot select **Adjust it from the image**.

### ■ Select and adjust the correction value

**1** Press the  button to display menus in the following order.  
**Image - Advanced - Gamma**

**2** Use the   buttons to select the correction value, and then press the  button to confirm the selection.

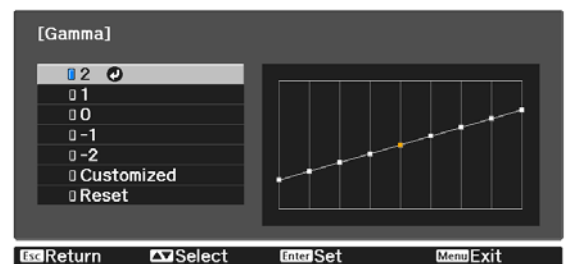

The larger the value, the lighter the dark portions of the image become, but bright areas may appear discolored. The upper part of the gamma adjustment graph becomes rounded.

The smaller the value, the darker the bright portions of the image become. The lower part of the gamma adjustment graph becomes rounded.



- The horizontal axis of the gamma adjustment graph shows the input signal level, and the vertical axis shows the output signal level.
- Select **Reset** to return the adjustments to their default values.





### ■ Adjust while viewing the image

Select a point on the image where you want to adjust the brightness, and adjust only the selected tone.

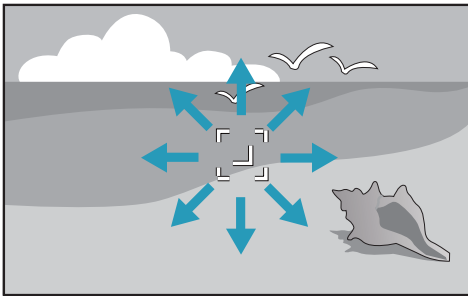
**1** Press the  button to display menus in the following order.  
**Image - Advanced - Gamma - Customized - Adjust it from the image**

**2** Move the cursor on the projected image to the part where you want to change the brightness, and then press the  button.



**3** Use the     buttons for adjustments, and then press the  button to confirm the selection.

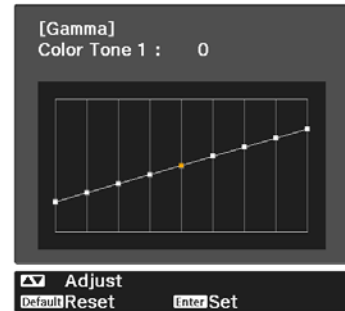



**4** When **Do you want to continue adjusting the setting?** is displayed, select **Yes** or **No**.

To adjust another location, select **Yes**, and repeat the procedure from step 2.



 Adjust using the gamma adjustment graph

Select a tone point on the graph and make adjustments.

**1** Press the  button to display menus in the following order.  
**Image - Advanced - Gamma - Customized - Adjust it from the graph**

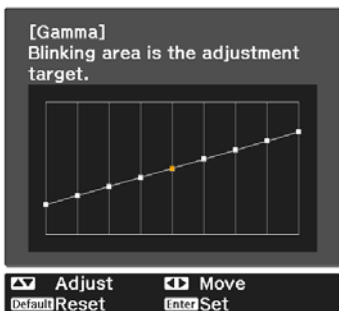
**2** Use the   buttons to select the tone you want to adjust from the graph.



**3** Use the   buttons to adjust the brightness, and then press the  button to confirm the selection.

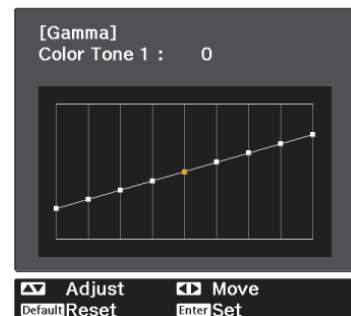

# Viewing the Image at the Saved Image Quality (Memory Function)

## Saving a Memory

By using the memory function, you can register settings for **Image** from the Configuration menu, and then load them when necessary.

**1** Make the settings or adjustments you want to register.

**2** Press the **Memory** button.

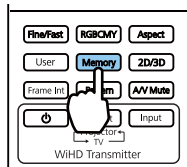

**3** Use the buttons to select **Save Memory**, and then press the button to confirm the selection.



**4** Use the buttons to select the memory name to be saved, and then press the button to confirm the selection.

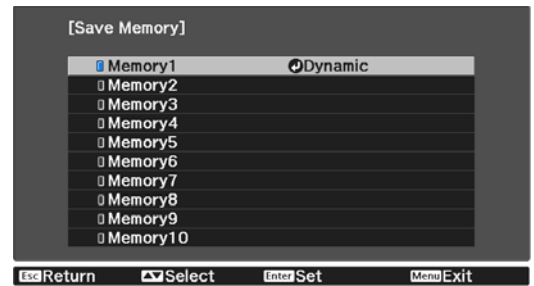

The current projector settings are saved to the memory.



If the mark on the left of the memory name is turned aqua, it means the memory has already been registered. When you select a registered memory, a message is displayed asking you to confirm that you want to overwrite the memory. If you select **Yes**, the previous content is erased and the current settings are saved.

## Loading, Deleting, and Renaming a Memory

You can load, delete, and rename registered memories.

Press the **Memory** button, and then select the target function on the screen displayed.



Function	Explanation
<b>Load Memory</b>	Loads the saved memory. When you select a memory and press the  button, the settings applied to the current image are replaced with the settings from the memory.
<b>Erase Memory</b>	Erases the registered memory. When you select a memory name and press the  button, a message is displayed. Select <b>Yes</b> , and then press the  button to erase the selected memory.

Function	Explanation
<b>Rename Memory</b>	<p>Changes the memory name. Select the memory name you want to change, and then press the  button. Enter the memory name using the soft keyboard.  <a href="#">p.96</a></p> <p>When you have finished, move the cursor over <b>Finish</b>, and then press the  button.</p>

# Enjoying 3D Images

## Preparing to View 3D Images

Check the following before viewing 3D images.

- When the source is HDMI1, HDMI2, or WirelessHD (EH-TW6700W only).
- Set **3D Display** to **Auto** or **3D**.  
When **2D** is set, press the  button on the remote control and switch to **Auto** or **3D**.  **Signal - 3D Setup - 3D Display** p.88
- Pair 3D Glasses.  p.51

This projector supports the following 3D formats.

- Frame Packing
- Side by Side
- Top and Bottom

### If the 3D image cannot be viewed

The projector automatically projects a 3D image when detecting a 3D format.

Some 3D TV broadcasts may not contain 3D format signals. If this happens, follow the steps below to set the 3D format.

- 1 Press the  button to set **3D Display** to **3D**.

The  button toggles **3D Display** between **Auto**, **3D**, and **2D**.

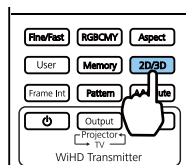

- 2 Press the  button to set the 3D format on the AV device.

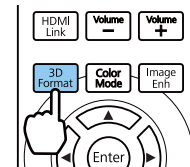



- If you are using a device or cable that does not support 3D images, 3D projection cannot be performed.
- For details on 3D format settings on the AV device, see the documentation supplied with the AV device.
- When the 3D format has not been correctly set up, an image will not be correctly projected as shown below.

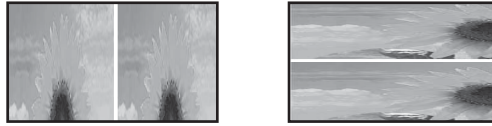

- If a 3D image is not projected correctly even when a 3D format is set, the synchronization timing for the 3D glasses may be inverted. Inverse the synchronization timing using **Inverse 3D Glasses**.  
 🗨 **Signal - 3D Setup - Inverse 3D Glasses** p.88
  - How a 3D image is perceived varies depending on the individual.
  - When you start projecting a 3D image, a warning about viewing 3D images is displayed. You can turn off this warning by setting **3D Viewing Notice** to **Off**. 🗨 **Signal - 3D Setup - 3D Viewing Notice** p.88
  - During 3D projection, the following Configuration menu functions cannot be changed. Aspect (set to Normal\*), Noise Reduction (set to Off), Overscan (set to Off), Super-resolution, Image Processing, Advanced - Sharpness, Picture in Picture
- \* For the EH-TW6800 only, you can select **Normal** or **Anamorphic Wide**.
- How the 3D image is viewed may change depending on the temperature of the surroundings and how long the lamp has been used. Refrain from using the projector if the image is not projected normally.

## Using 3D Glasses

Use the supplied or optional 3D Glasses (ELPGS03) to view 3D images. 🗨 p.128



The 3D Glasses come with protective stickers. Remove the protective stickers before use.

### Charging the 3D Glasses

The following charging methods are available, depending on the model of 3D Glasses being used.

If you have a WirelessHD Transmitter, you can use it to charge the glasses.

If you do not have a WirelessHD Transmitter, you can charge by using a USB Charging Adapter (ELPAC01).

#### Charging using the WirelessHD Transmitter

Use the USB cable to connect the 3D Glasses to the WirelessHD Transmitter.

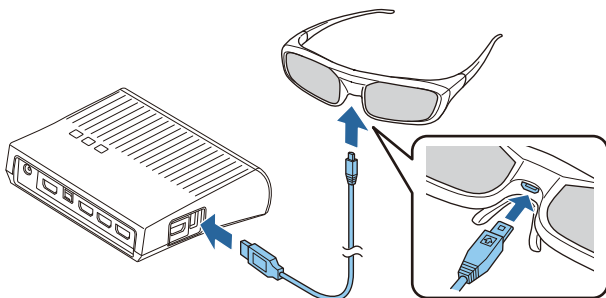

When a cable is connected to the HDMI4 port, the WirelessHD Transmitter cannot charge 3D glasses.

#### Charging using the USB Charging Adapter

Use the USB charging cable to connect the 3D Glasses to the USB Charging Adapter, and then connect the USB Charging Adapter to an electrical outlet.

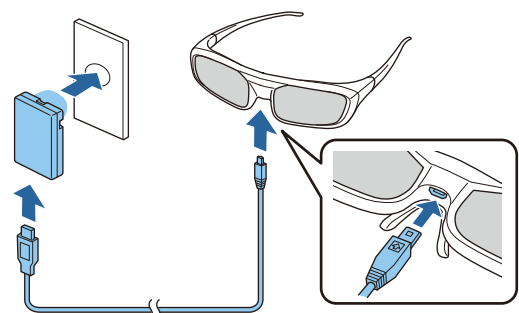



- You can only charge the 3D Glasses ELPGS03.
- Make sure you use the USB cable supplied for the 3D glasses.
- You can use the glasses for approximately three hours after charging for just three minutes. A full charge takes 50 minutes and the glasses can be used for approximately 40 hours.
- You can also charge by connecting the 3D Glasses to the projector. When using the projector to charge the 3D glasses, connect the USB charging cable to the projector's USB port. (Only when the projector is turned on.)

### Attention

---

- Only connect to an electrical outlet that uses the voltage displayed on the adapter.
- Note the following points when handling the USB cable.
  - You should not bend, twist, or pull the cable with too much force.
  - You should not modify the cable.
  - You should not perform wiring near an electric heater.
  - You should not use the cable if it is damaged.

### ■ Pairing 3D Glasses

---

To view 3D images, you first need to pair the 3D Glasses with the projector.

Press the [Pairing] button for a while on the 3D Glasses to start pairing. See the User's Guide for the 3D Glasses for more information.



- When using the 3D Glasses for the first time, pairing is performed when the 3D Glasses are turned on. You do not need to perform pairing if 3D images can already be viewed correctly.
- Once pairing has been performed, you can view 3D images the next time the devices are turned on.
- You can perform pairing within a range of three meters from the projector. While pairing is being performed, make sure you stay within a range of three meters from the projector. Otherwise, pairing will fail.
- If synchronization cannot be performed within 30 seconds, pairing is automatically canceled. When pairing is cancelled, 3D images cannot be viewed because pairing fails.



■ Wearing 3D Glasses

**1** Turn on the 3D Glasses by sliding the [Power] switch to On.

The indicator turns on for several seconds, and then turns off.

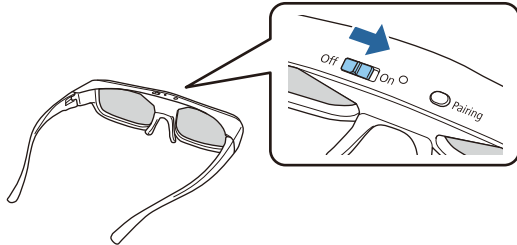

**2** Put on the 3D Glasses and enjoy the show.



- When you have finished using the 3D Glasses, turn them off by sliding the [Power] switch to Off.
- If the 3D Glasses are not used for at least 30 seconds, they turn off automatically. To turn the 3D Glasses back on, slide the [Power] switch to Off, and then slide it back to On.

■ Reading the indicator on the 3D Glasses

You can check the status of the 3D Glasses by whether its indicator is lit or flashing.

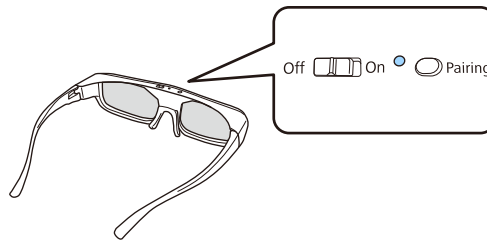

Indicators	Status
Flashing red quickly twice; repeated 5 times	Weak battery
Lit red	Charging
Lit green	Charging completed
Flashes green and red in turn	Pairing
Lit green for 10 seconds and then turns off	Power on or pairing succeeded

Converting 2D Images to 3D

You can convert 2D images from HDMI1, HDMI2, or WirelessHD (EH-TW6700W only).

**1** Press the **[2D/3D]** button to set **3D Display to Auto**.

The **[2D/3D]** button toggles **3D Display** between **Auto**, **3D**, and **2D**.

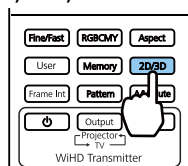

**2** Press the **[Menu]** button to display menus in the order **Signal - 3D Setup**.

- 3** Select **2D-to-3D Conversion**, and then press the **Enter** button to confirm the selection.

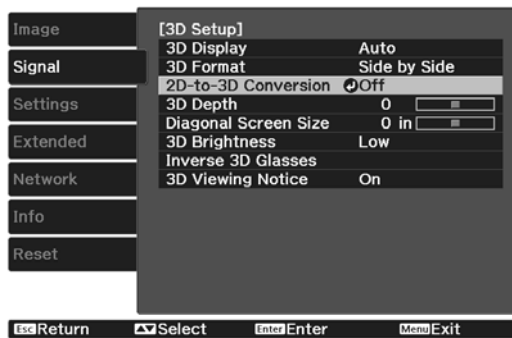

- 4** Select the strength of the 3D effect, and then press the **Enter** button to confirm the selection.

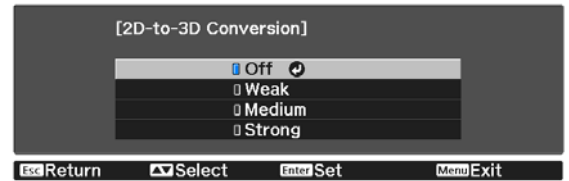

If **Image Processing** is set to **Fast**, you cannot adjust **2D-to-3D Conversion**. **Signal - Advanced - Image Processing p.88**

## Warnings Regarding Viewing 3D Images

Note the following important points when viewing 3D images.

### Warning

#### Disassembling or remodeling

- Do not disassemble or remodel the 3D Glasses.  
This could cause a fire to occur or the images to appear abnormal when viewing, causing you to feel unwell.

#### Storage locations

- Do not leave the 3D Glasses or the supplied parts within reach of children.  
They could be accidentally swallowed. If anything is accidentally swallowed, contact a doctor immediately.

#### Heating

- Do not place the 3D Glasses in a fire, on a heat source, or leave them unattended in a location subject to high temperatures. Because this device has a built-in rechargeable lithium battery, it could cause burns or a fire if it ignites or explodes.

#### Charging

- When charging, connect the supplied cable to the USB port designated by Epson. Do not charge using other devices as it may cause the battery to leak, overheat, or explode.
- Only use the supplied charging cable to charge the 3D Glasses. Otherwise, it could overheat, ignite, or explode.

 **Caution**

---

3D Glasses

- Do not drop or press too forcefully on the 3D Glasses.  
If the glass sections and so on are broken, an injury could occur. Store the glasses in the soft glasses case.
- Be careful of the edges of the frame when wearing the 3D Glasses.  
If it pokes your eye and so on, an injury could occur.
- Do not place your finger in any of the moving sections (such as the hinges) of the 3D Glasses.  
Otherwise an injury could occur.

 **Caution**

---

Wearing 3D Glasses

- Make sure you wear the 3D Glasses correctly.  
Do not wear the 3D Glasses upside down.  
If the image is not displayed correctly into the right and left eyes, it could cause you to feel unwell.
- Do not wear the glasses unless you are viewing a 3D image.
- How a 3D image is perceived varies depending on the individual. Stop using the 3D function if you feel strange or cannot see in 3D.  
Continuing to view the 3D images could cause you to feel unwell.
- Stop wearing the 3D Glasses immediately if they seem abnormal or a malfunction occurs.  
Continuing to wear the 3D Glasses could cause an injury or cause you to feel unwell.
- Stop wearing the 3D Glasses if your ears, nose, or temples become red, painful, or itchy.  
Continuing to wear the 3D Glasses could cause you to feel unwell.
- Stop wearing the 3D Glasses if your skin feels unusual when wearing the glasses.  
In some very rare cases the paint or materials used in the 3D Glasses could cause an allergic reaction.

 **Caution**

---

Viewing Time

- When viewing 3D images, always take periodic breaks during extended viewing.  
Long periods of viewing 3D images may cause eye fatigue.  
The amount of time and frequency of such breaks varies from person to person. If your eyes still feel tired or uncomfortable even after taking a break from viewing, stop viewing immediately.

 **Caution**

Watching 3D Images

- If your eyes feel fatigued or uncomfortable when viewing 3D images, stop viewing immediately. Continuing to view the 3D images could cause you to feel unwell.
- When viewing 3D images be sure to always wear 3D Glasses. Do not attempt to view 3D images without 3D Glasses. Doing so could cause you to feel unwell.
- Do not place any breakable or fragile objects around you when using 3D Glasses. 3D images may cause you to move your body involuntarily, resulting in damage to nearby items or personal injury.
- Only wear 3D Glasses when viewing 3D images. Do not move around while wearing 3D Glasses. Your vision may appear darker than normal, causing you to fall or injure yourself.
- Try to stay as level with the viewing screen as possible when viewing 3D images. Viewing 3D images at an angle reduces the 3D effect and may cause you to feel unwell due to unintended color changes.
- If using 3D Glasses in a room with fluorescent or LED lighting, you may see flashing or flickering throughout the room. If this should occur, reduce the lighting until the flickering goes away or turn off the lights completely when viewing 3D images. In some very rare cases, this flickering could trigger seizures or fainting for some individuals. If you begin to feel uncomfortable or unwell at any time when viewing 3D images, stop immediately.
- Stay at least three times the height of the screen away from the screen when viewing 3D images. The recommended viewing distance for an 80-inch screen is at least 3 meters, and at least 3.6 meters for a 100-inch screen. Sitting or standing any closer than the recommended viewing distance may result in eye fatigue.

 **Caution**

Health Risks

- You should not use 3D Glasses if you are sensitive to light, have a heart condition, or are unwell. Doing so could aggravate your pre-existing conditions.

 **Caution**

Recommended Age of Use

- The minimum recommended age to view 3D images is six years old.
- Children under the age of six are still developing and viewing 3D images may cause complications. Consult your doctor if you have any concerns.
- Children viewing 3D images through 3D Glasses should always be accompanied by an adult. It is often difficult to tell when a child is feeling tired or uncomfortable, which could result in them feeling suddenly unwell. Always check with your child to ensure that they are not experiencing any eye fatigue during viewing.



## Connecting with WirelessHD (EH-TW6700W Only)

### Installing the WirelessHD Transmitter

You can use the supplied WirelessHD Transmitter to wirelessly receive image and sound data.

This is useful when the projector cannot be setup near your AV devices as you can connect the devices to the projector without using cables.



You can use the WirelessHD Transmitter in the following ways.

- You can connect up to four AV devices at the same time, and switch images using the remote control.
- As well as the projector, you can connect another monitor device, such as a television, to the HDMI Out port, and then switch the output using the remote control.
- This allows other monitor devices such as TVs connected to the HDMI Out port to project images from the connected AV device, even if the projector is off.
- You can connect smart devices and tablets that support MHL, and then project images from the connected MHL device. You can also operate MHL devices from the projector's remote control, as well as charge the MHL device.
- You can split the HDMI signal that is being input into the WirelessHD Transmitter into image and audio, and output to other devices.
- Even for AV devices that do not support HDCP 2.2, you can output audio by connecting to the HDMI Out port on the WirelessHD Transmitter.





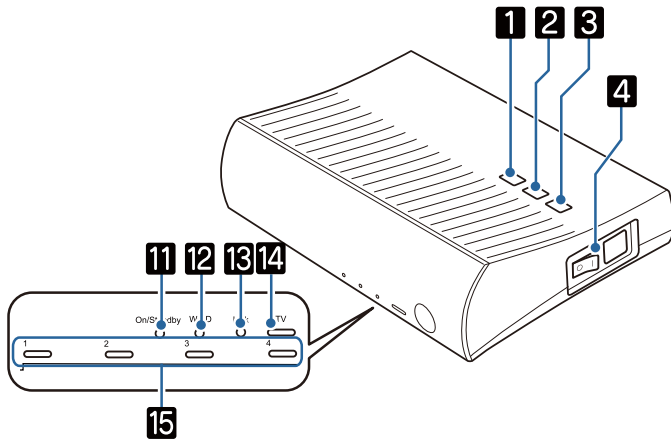

WirelessHD Transmitter part names

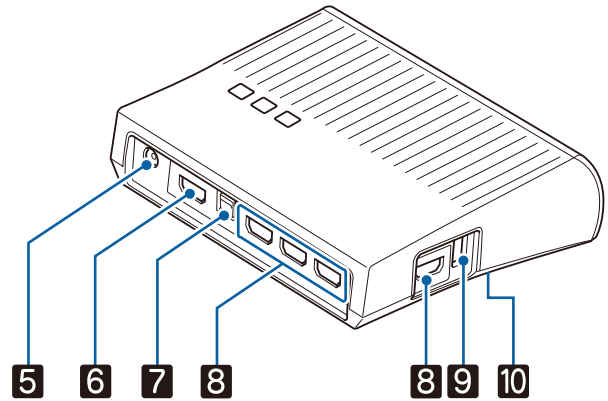
Front



Rear



Name		Function
<b>1</b>	⏻ button	Turns the transmitter on or off. This performs the same function as the  button for the WirelessHD Transmitter control on the lower section of the remote control.
<b>2</b>	 button	Changes to the image from each input port. This performs the same function as the  button for the WirelessHD Transmitter control on the lower section of the remote control.
<b>3</b>	 button	Switches the output image to the projector or the device connected to the HDMI Out port. This performs the same function as the  button for the WirelessHD Transmitter control on the lower section of the remote control.
<b>4</b>	Main power switch	Turns the main power for the transmitter on or off.
<b>5</b>	AC adapter port	Connects the AC adapter.
<b>6</b>	HDMI Out port	Connects to a monitor device, such as a television. You can switch the monitor devices using the  button on the remote control or the  button on the WirelessHD Transmitter.
<b>7</b>	Optical Audio-Out port	Connects to an audio device equipped with an optical digital audio input port.
<b>8</b>	HDMI Input port	Connects to the AV device you want to playback. You can switch the input image using the Input button.  The HDMI4 port of the unit meets the MHL standards. You can play content from MHL compatible smart devices or tablets connected with an MHL cable.
<b>9</b>	3D Glasses charging port	Connects a USB cable to charge the 3D Glasses.
<b>10</b>	Setup button	This is the button on the back of the WirelessHD Transmitter. It is used for setting the WirelessHD Transmitter. Since this is already set when the transmitter is shipped, it should not normally be used.
<b>11</b>	On/Standby indicator (blue)	This flashes while the WirelessHD Transmitter is starting up, and remains lit while operating.

Name		Function
<b>12</b>	WiHD indicator (blue)	Indicates the communication status for the WirelessHD. <ul style="list-style-type: none"> <li>• Lit when wirelessly transmitting images to the projector.</li> <li>• Off when outputting to the HDMI Out port.</li> </ul>
<b>13</b>	Link indicator (blue)	Indicates the connection status with the projector. <ul style="list-style-type: none"> <li>• Turns on when connected to the projector.</li> <li>• Flashes when searching for a projector.</li> <li>• Flashes slowly when standing by in power saving status.</li> </ul>
<b>14</b>	TV indicator (blue)	Lit when a monitor device such as a TV is selected as the output.
<b>15</b>	HDMI1 to 4 indicators (blue)	The indicator for the source currently being projected is lit.



- The antennas are built-into the front of the projector and the WirelessHD Transmitter. Make sure the antennas face each other (face the front) when setting up the devices. Also, do not place any object over the front side of the projector and WirelessHD Transmitter.
- Place the WirelessHD Transmitter on a level surface facing towards the projector.
- You can view the signal strength from the **WirelessHD** settings menu. **Settings - WirelessHD - Video Reception** p.89

## ■ WirelessHD Transmitter connection example and signal flow



- When outputting audio from devices connected to the Optical Audio-Out port or the HDMI Out port, set the output audio in **Audio Out Device**. p.70
- You can output images from the projector or a monitor device such as TV. You can switch the monitor devices using the button on the remote control or the button on the WirelessHD Transmitter. p.68
- When inputting images from HDMI Input1 or HDMI Input2 port, if noise is generated by monitors such as televisions or if the audio is lost, try connecting to the HDMI Input3 or HDMI Input4 port.

Connection example 1: Viewing without an AV amplifier (audio is output from the Optical Audio-Out port)

Audio is output from the sound bar connected to the Optical Audio-Out port. Use a commercially available optical digital cable to connect to the sound bar.

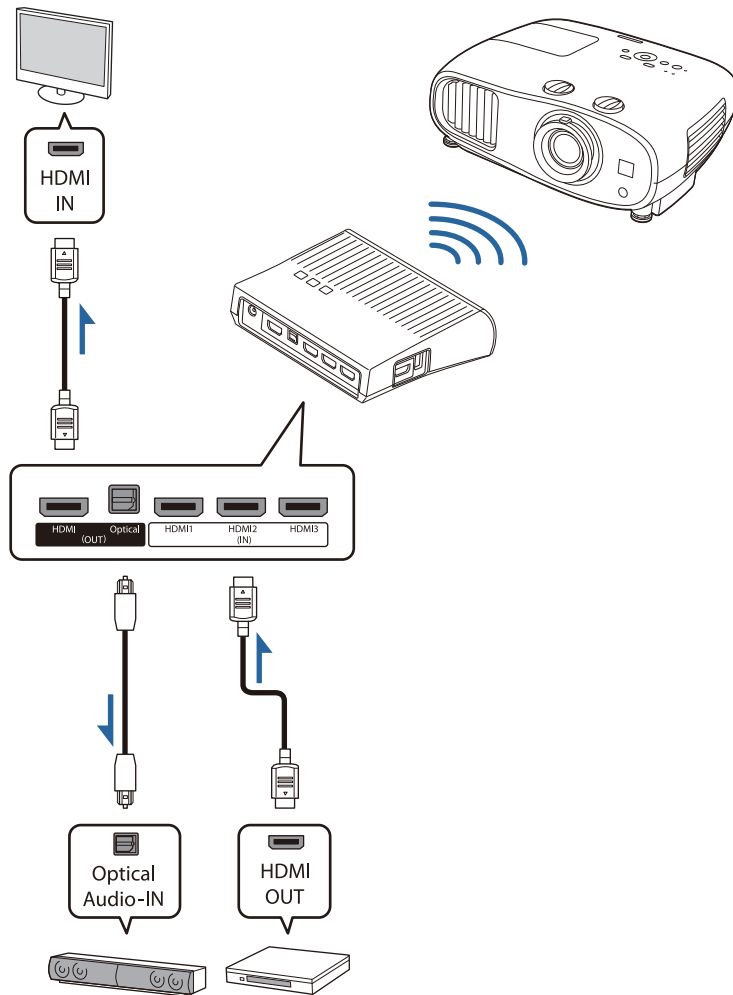

- When connecting a device, such as a sound bar, to the Optical Audio-Out port on the WirelessHD Transmitter, check that **Audio Out Device** is set to **WiHD Transmitter (Optical)**. **Settings - HDMI Link - Audio Out Device** [p.89](#)
  - You cannot output some audio from the Optical Audio-Out port due to restrictions in audio standards\*.
    - Lossless audio
    - Lossy high-bandwidth audio
    - Immersive audio
- \* As of July 2016. This may be changed in the future.



Connection example 2: Viewing without an AV amplifier (audio is output from the HDMI Out port)

Audio is output from the sound bar and so on connected to the HDMI Out port. In this situation, you can even output audio from AV amplifiers or sound bars that do not support HDCP 2.2.

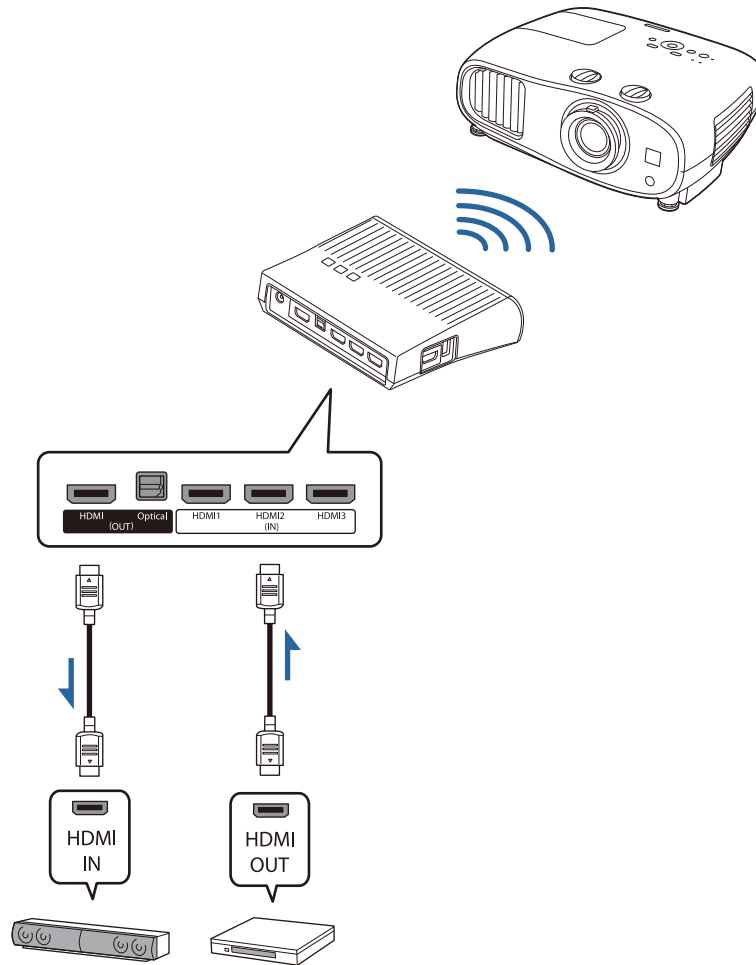

When connecting a device, such as a sound bar, to the HDMI Out port on the WirelessHD Transmitter, check that **Audio Out Device** is set to **WiHD Transmitter (HDMI)**. **Settings - HDMI Link - Audio Out Device** [p.89](#)

### Connection example 3: Viewing with a connected AV amplifier

Connect using an AV amplifier.

Audio is output from the AV amplifier.

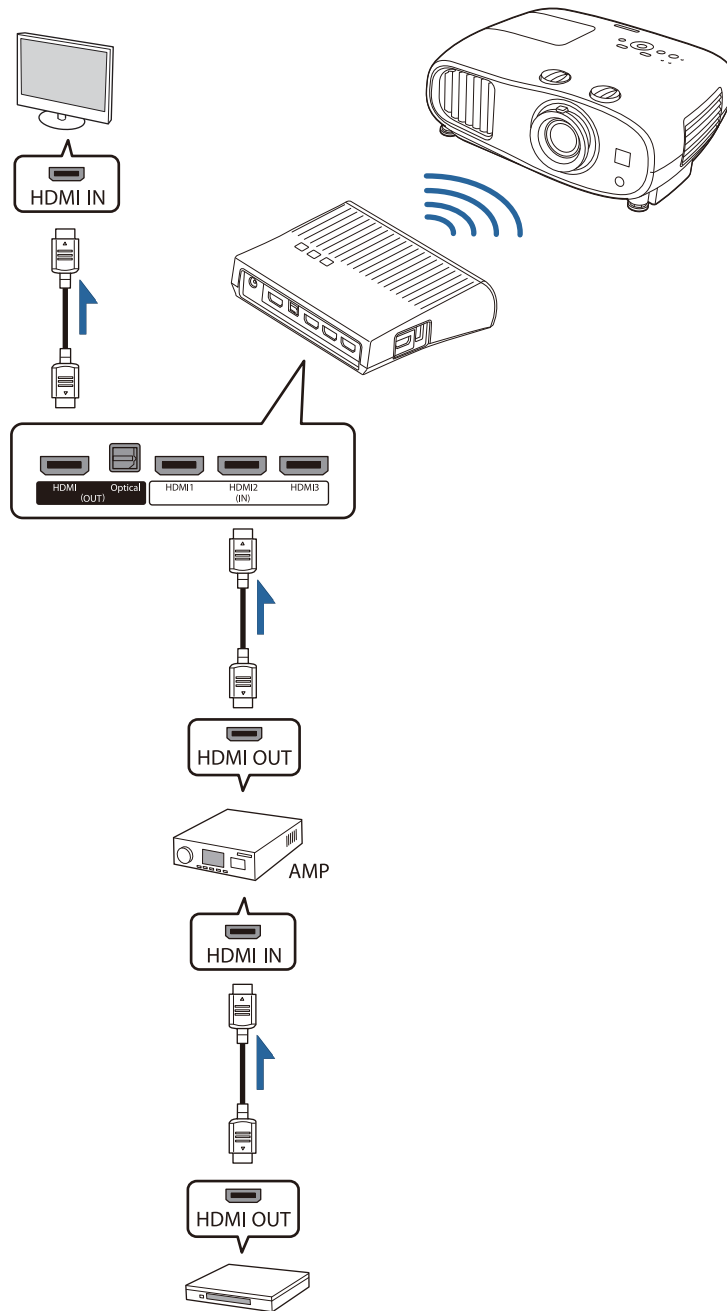

### Connection example 4: Viewing with a connected smart device

Connect an MHL cable to the HDMI4 port.

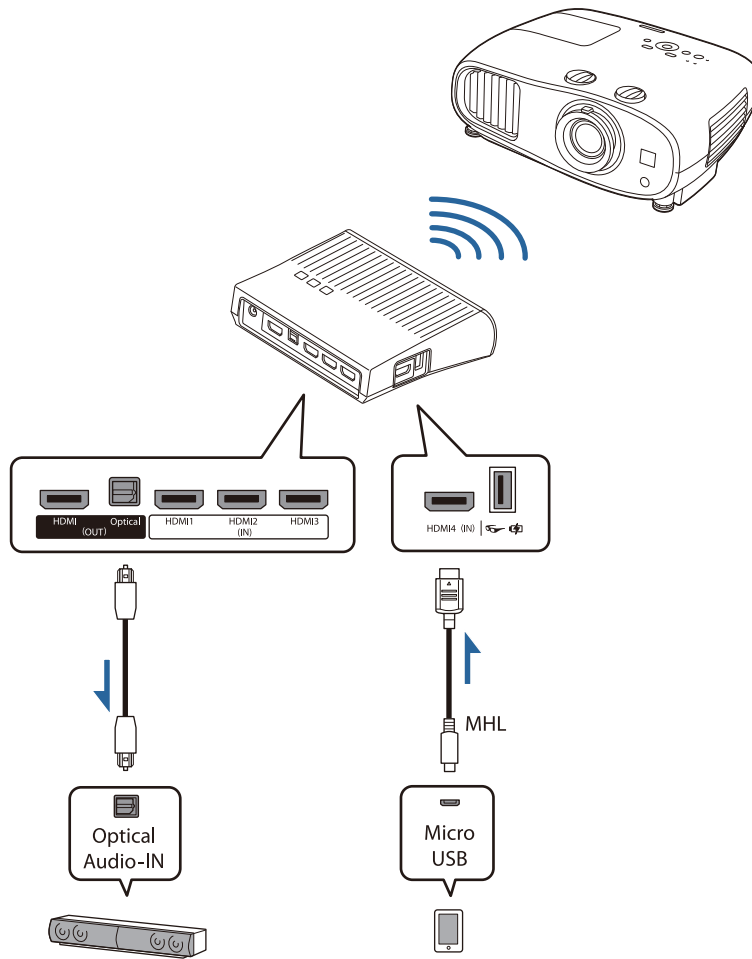

Setting the WirelessHD Transmitter

**1** Set up the WirelessHD Transmitter connected to the projector so that they are facing each other. p.56

- The antennas are built-into the front of the projector and the WirelessHD Transmitter. Make sure the antennas face each other (face the front) when setting up the devices. Also, do not place any object over the front side of the projector and WirelessHD Transmitter.
- Place the WirelessHD Transmitter on a level surface facing towards the projector.

**2** Connect the WirelessHD Transmitter to an electrical outlet using the supplied AC adapter.

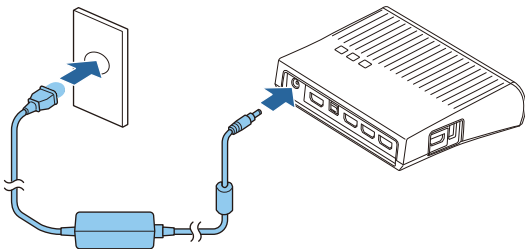

**3** Using an HDMI cable, connect the AV device you want to use to the Input port on the WirelessHD Transmitter. You can connect up to four multi-media players.

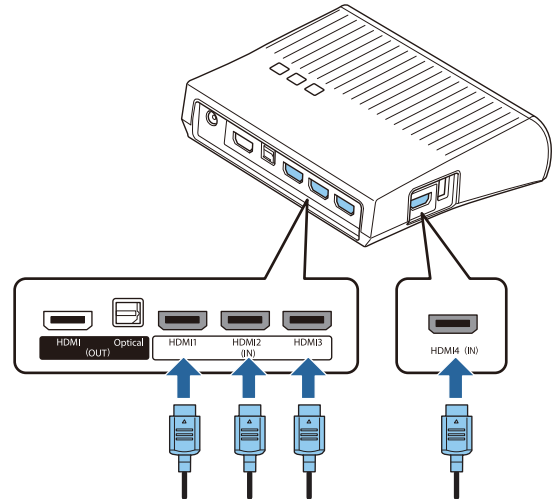

- You can connect another monitor device, such as a television, to the HDMI Out port on the WirelessHD Transmitter. You can switch between output images using the remote control. p.68
- The HDMI4 port of the WirelessHD Transmitter supports the MHL input signal. You can play content from MHL compatible smart devices or tablets connected with an MHL cable.
- If the following message is displayed when you connect an MHL device, the device has been connected to a port other than the HDMI4 port, or the connected device is not compatible with MHL.  
**"No Signal"**
- You can use the HDMI link function even when using the WirelessHD Transmitter. p.70

Projecting Images

**1** Start playback on the AV device, and then turn on the projector and the WirelessHD Transmitter.

The On/Standby indicator on the WirelessHD Transmitter turns on.

2

Check the status of the WiHD indicator on the WirelessHD Transmitter.

If the WiHD indicator is on, go to the next step.

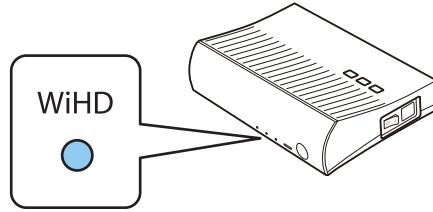

If the indicator is off, press the **Output** button on the remote control or the **WiHD/Pass** button on the WirelessHD Transmitter.

Make sure you point the remote control at the WirelessHD Transmitter when using the **Output** button on the remote control.

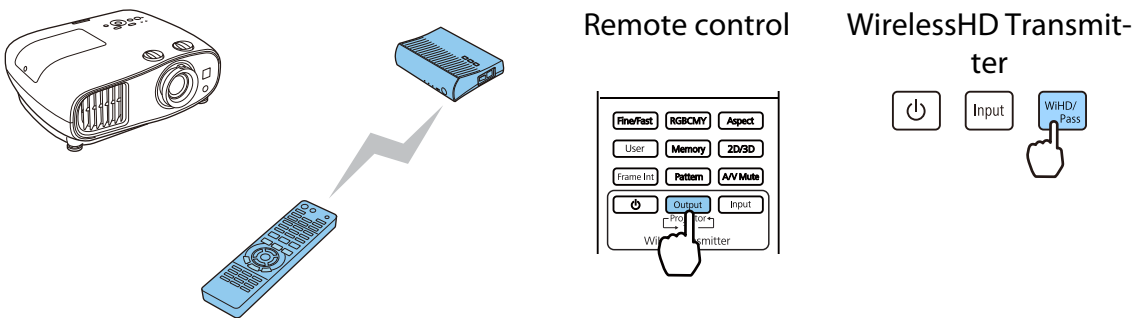

3

Check the status of the Link indicator on the WirelessHD Transmitter.

If the WirelessHD Transmitter is connected to the projector, the Link indicator turns on.

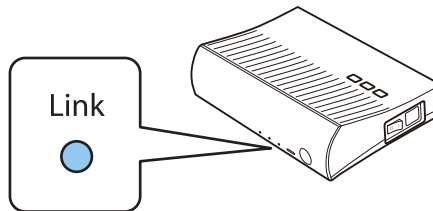

- If the indicator does not turn on, check that the projector has been prepared correctly and that it is turned on.
- You can view the signal strength while images are being projected from the **WirelessHD** settings menu. **Settings - WirelessHD - Video Reception p.89**

**4** If projection does not start, press the **WirelessHD** button on the remote control to change the source.

Make sure you point the remote control at the projector when using the **WirelessHD** button on the remote control.

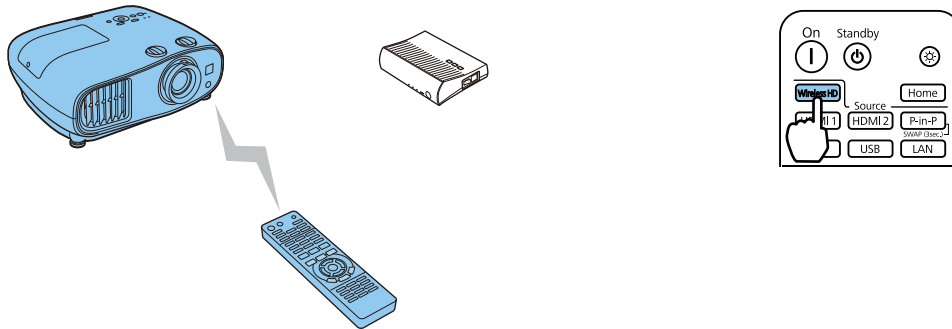

Projection starts.

**5** When connecting two or more AV devices to the WirelessHD Transmitter, press the **Input** button to switch images. [p.69](#)



- When receiving WirelessHD images, make sure **WirelessHD** is set to **On** from the Configuration menu. **Settings - WirelessHD - WirelessHD p.89**
- Make sure you turn off the WirelessHD Transmitter if it is not going to be used for an extended period.

## WirelessHD Settings Menu

**1** Press the **Menu** button.  
The Configuration menu is displayed.

**2** Select **Settings - WirelessHD**, and then press the **Enter** button to confirm the selection.  
The **WirelessHD** settings screen is displayed.

**3** Make settings for each of the displayed functions.

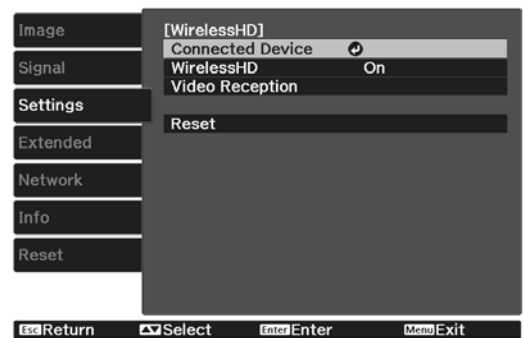

Available functions on the **WirelessHD** settings menu

Function	Explanation
Connected Device	Displays the available WirelessHD device that can be connected. The device name and MAC address (device number) are displayed. The MAC address is displayed on the label on the base.
WirelessHD	Enables or disables the WirelessHD function.
Video Reception	Displays the reception for the image being projected.
Reset	Resets <b>WirelessHD</b> settings to their default settings.



Even when the WirelessHD Transmitter and the projector are connected, 0% is displayed as the **Video Reception** when no image signal is being input. Check the communication status by viewing the Link indicator. 🖱️ [p.57](#)

## WirelessHD Transmission Range

The following shows the communication range of the WirelessHD. Make sure you set up the WirelessHD Transmitter so that it faces the projector.

Horizontal

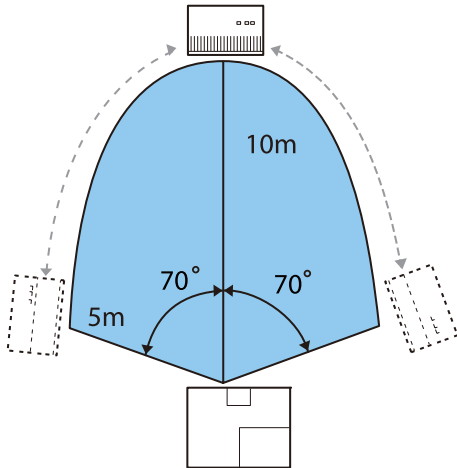

Vertical direction (suspended from a ceiling)

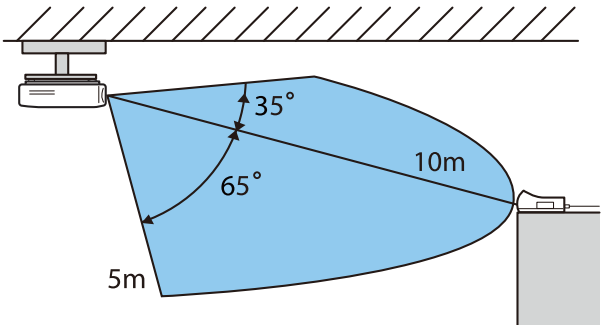



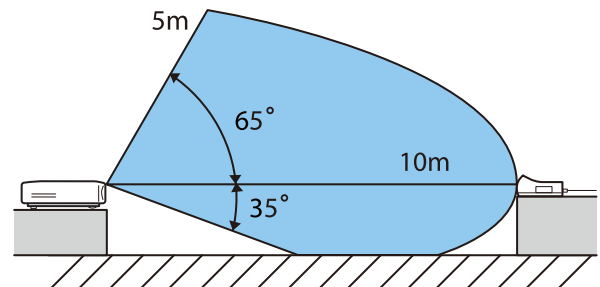



Vertical direction (placed on a table and so on)

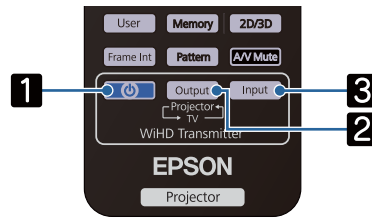

- The wireless transmission range varies depending on the placement and material of the surrounding furniture and walls. The values given here are for your reference only.
- The projector cannot communicate through walls.
- The antennas are built-into the front of the projector and the WirelessHD Transmitter. Make sure the antennas face each other (face the front) when setting up the devices. Also, do not place any object over the front side of the projector and WirelessHD Transmitter.
- Do not install the transmitter on a metal shelf. The metal may make the signal unstable. Install on a shelf made from wood etc.
- When checking operations, place the projector and the WirelessHD Transmitter close to each other, and make sure there are no other projectors operating in the vicinity.
- Depending on the reception strength, the image's color information may be automatically discarded to avoid any interruptions and maintain a constant connection. To avoid any deterioration in image quality, adjust the position of the WirelessHD Transmitter so that the **Video Reception** is as strong as possible.
- Reception sensitivity varies depending on the resolution of the input image.

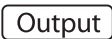
## Operating the Remote Control

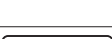

Name	Function
<b>1</b> 	Turns the power for the WirelessHD Transmitter on or off.
<b>2</b> 	Switches the output image between a monitor device, such as a television, connected to the HDMI Out port on the WirelessHD Transmitter and the projector.  <a href="#">p.68</a>
<b>3</b> 	Switches the image source for the AV device connected to the WirelessHD Transmitter.  <a href="#">p.69</a>



Point the remote control towards the WirelessHD Transmitter.

## Remote Control Operating Range

The following shows the operating range between the remote control and the WirelessHD Transmitter.

Operating range (left to right)

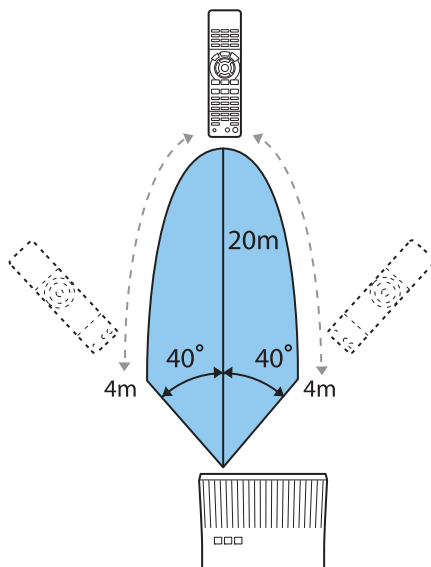

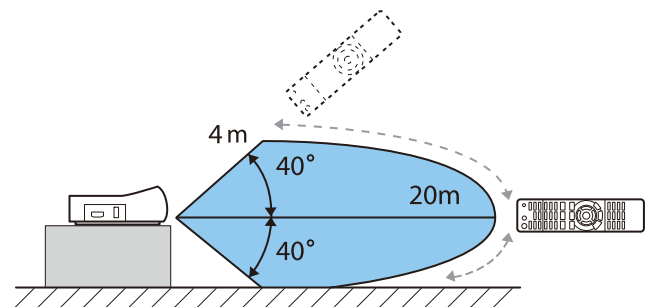

Operating range (top to bottom)



## Switching the Input and Output

With the WirelessHD Transmitter, you can connect and switch between up to four multi-media players (input devices to be played back) and one monitor device (a monitor device displaying an image, such as a television).

Point the remote control at the WirelessHD Transmitter and press its  **Input** button to switch between input devices and its  **Output** button to switch between output devices.



Switching the target image

You can switch between a monitor device, such as a television, connected to the HDMI Out port on the WirelessHD Transmitter and the projector.

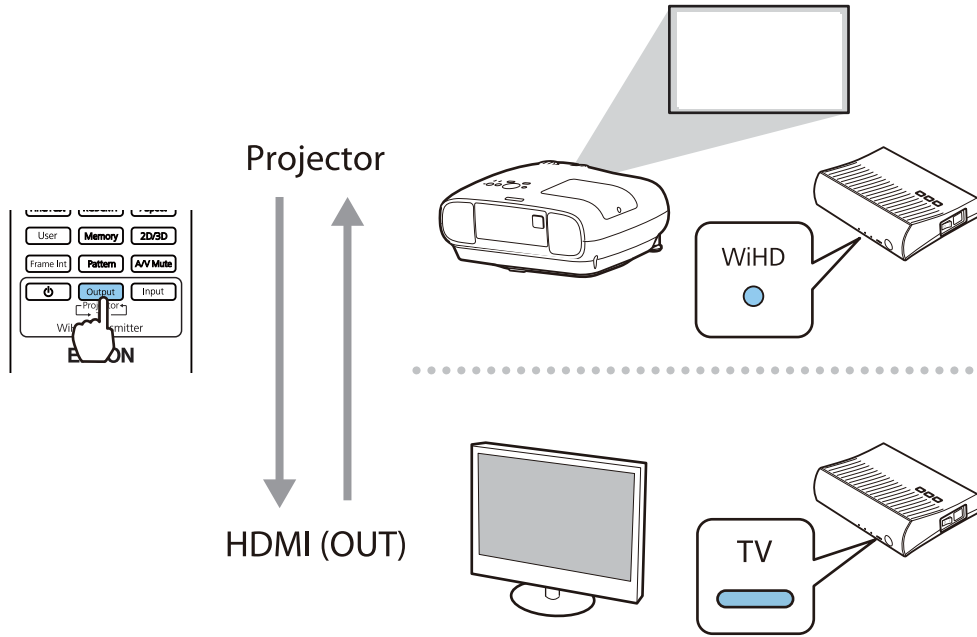

- 1 Turn on the projector or the monitor device, such as a television.
- 2 Turn on the WirelessHD Transmitter.  
The On/Standby indicator on the WirelessHD Transmitter turns on.
- 3 Point the remote control at the WirelessHD Transmitter, and then press the **Output** button on the remote control or the **WiHD/Pass** button on the WirelessHD Transmitter.

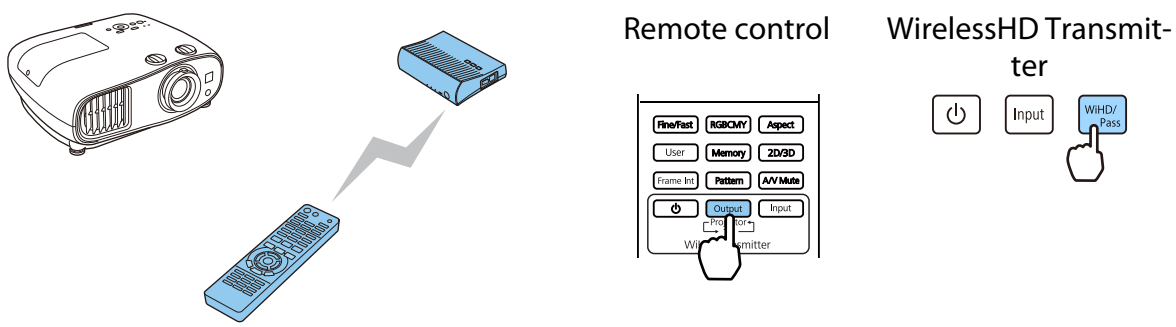

Depending on the output target, the indicators on the WirelessHD Transmitter indicate the following status. The output target projected last time is projected the next time the projector is turned on.  
 WiHD indicator On: The image is being output to the projector.  
 TV indicator On: The image is being output to the monitor device.

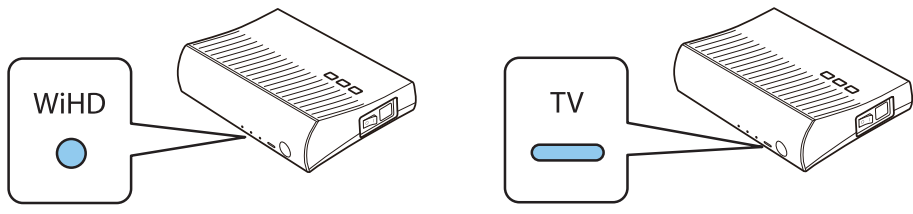



You can switch to the other monitor device even when the projector is off.

### ■ Switching the image source

Use the **Input** button on the remote control to switch the image source for the AV device connected to the WirelessHD Transmitter.

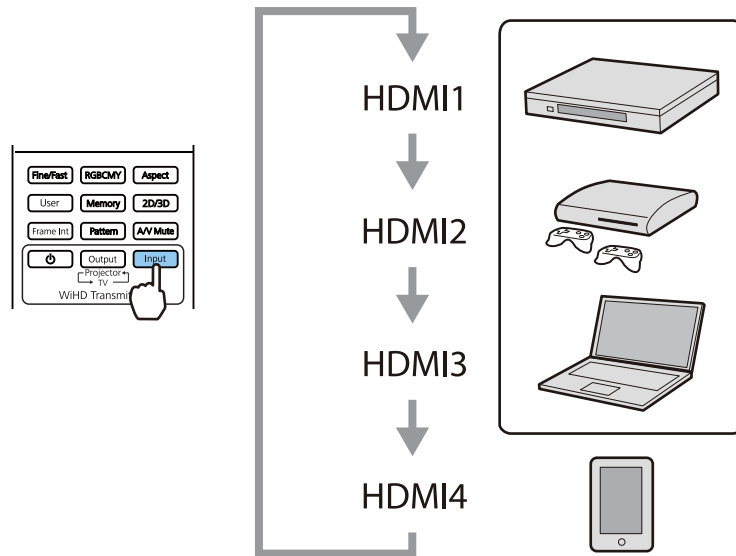

# Using the HDMI Link Function

## HDMI Link Function

When an AV device that meets the HDMI CEC standards is connected to the projector's HDMI port, you can perform linked operations such as linked power on and volume adjustment for the AV system from one remote control. Also, when projecting images in WirelessHD, you can use the HDMI link function. (EH-TW6700W only)

- As long as the AV device meets the HDMI CEC standards, you can use the HDMI link function even if the AV system in-between does not meet the HDMI CEC standards.
- Up to 3 multi-media players that meet the HDMI CEC standards can be connected at the same time.

### Connection Example

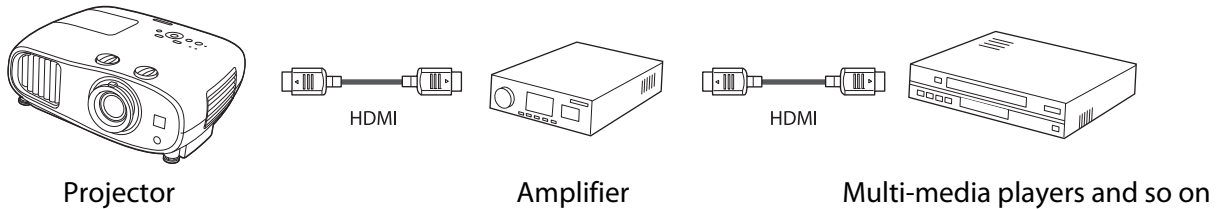

## HDMI Link Settings

When **HDMI Link** is set to **On**, you can perform the following operations. **Settings - HDMI Link - HDMI Link p.89**

- Input Change Link**  
Changes the input source of the projector to HDMI when content is played back on the connected device.
- Connected Devices Operations**  
Using the projector's remote control, you can perform operations such as Play, Stop, Fast Forward, Rewind, Next Chapter, Previous Chapter, Pause, Volume Adjustment, and Audio Mute.

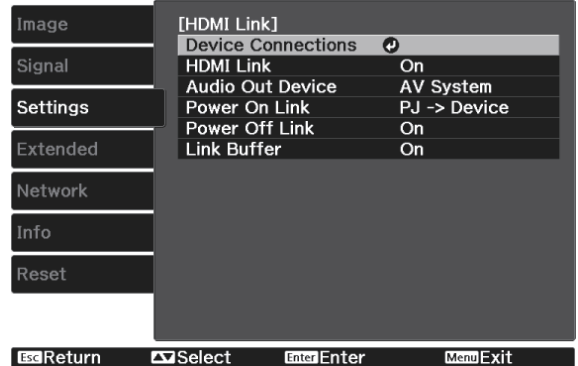

You can also select the following functions from the **HDMI Link** screen.

Function	Explanation
Audio Out Device	<p>Selects which device outputs audio.</p> <p><b>Projector:</b> Outputs audio from the projector's built-in speakers.</p> <p><b>AV System:</b> Select this to output audio from an AV amplifier that supports the HDMI CEC standards.</p> <p><b>WiHD Transmitter (Optical)*:</b> Select this to output audio from the device connected to the Optical Audio-Out port on the WirelessHD Transmitter.</p> <p><b>WiHD Transmitter (HDMI)*:</b> Select this to output audio from the device connected to the HDMI Out port on the WirelessHD Transmitter.</p>

Function	Explanation
Power On Link	When <b>Power On Link</b> is set, operations are linked as shown below. <ul style="list-style-type: none"> <li>• When the projector is turned on, the connected devices are also turned on.</li> <li>• Also, when the connected devices are turned on and content is played back, the projector turns on. However, the projector does not turn on when connected to the WirelessHD Transmitter even when the connected device is turned on.</li> </ul>
Power Off Link	When <b>Power Off Link</b> is set to <b>On</b> , when the projector is turned off, the connected devices are also turned off. <ul style="list-style-type: none"> <li>• This only works when the connected device's CEC power link function is enabled.</li> <li>• Note that depending on the status of the connected device (for example, if it is recording), the device may not power off.</li> </ul>
Link Buffer	If HDMI Link is not working correctly, you may be able to improve it by changing the settings.

\* EH-TW6700W only.



To use the HDMI Link function, you must configure the connected device. See the documentation supplied with the connected device for more information.

## Connecting

You can check the connected devices that are available for HDMI Link, and select on the device you want to project the image from. Devices that can be controlled by HDMI Link automatically become the selected device.

Before displaying the list of connected devices, check that **HDMI Link** is set to **On**. [Settings - HDMI Link - HDMI Link p.89](#)

**1** Press the  button, and then select **Device Connections**.

The **Device Connections** list is displayed.  
 Devices that have an aqua icon to their left are linked by HDMI Link.  
 If the device name cannot be determined this field is left blank.

**2** Select the device you want to operate using the HDMI Link function.

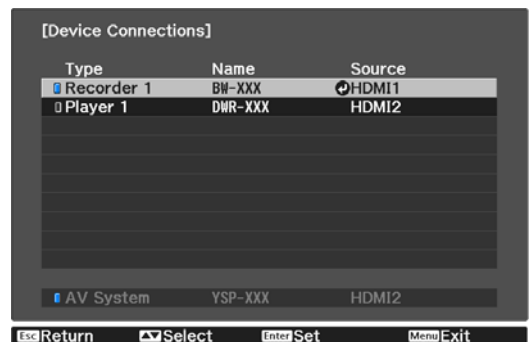

- If the cable does not meet the HDMI standards, operations are not possible.
- Some connected devices or functions of those devices may not operate properly even if they meet the HDMI CEC standards. See the documentation and so on supplied with the connected device for more information.

## Playing Back Image Data (Slideshow)

### Compatible Data

The following types of files stored on USB storage devices such as USB memories and digital cameras that are connected to the projector's USB port can be displayed as a slideshow.

#### Slideshow compatible file types

File Type (Extension)	Notes
.jpg	<ul style="list-style-type: none"> <li>• Images using CMYK color mode are not compatible.</li> <li>• Progressive format images are not compatible.</li> <li>• Images with a resolution greater than 8192 x 8192 are not compatible.</li> <li>• Due to the characteristics of JPEG files, images may not be projected clearly if the compression ratio is too high.</li> </ul>

### Starting a Slideshow

1

Connect a USB storage device.

Files are displayed as thumbnails.



To open a folder, select the folder, and then press the  button.





2

Select **Slideshow**.

Use the     buttons to select **Slideshow** at the bottom right of the screen, and then press the  button.

Slideshow starts.



- To close the slideshow, disconnect the USB storage device.
- Select an image from the thumbnails and press the  button to enlarge the selected image. Press the   buttons on the remote control when viewing an enlarged image to change between images. You can also rotate the image using the   buttons.

### Settings for Slideshow

You can set the file display order and slideshow operations on the option screen.

- 1 Use the     buttons to position the cursor over the folder where you want to change settings, and then press the  button.

The submenu is displayed.





- 2 Select **Option**, and then press the  button.

The option screen is displayed.

- 3 Position the cursor over the item you want to change, and press the  button to make settings for each item.

The following table shows the details for each item.

Display Order	You can select to display the files in <b>Name Order</b> or <b>Date Order</b> .
Sort Order	You can select to sort the files <b>In Ascending</b> or <b>In Descending</b> order.
Continuous Play	You can set whether to repeat the play.
Screen Switching Time	When playing a slideshow, you can set the time for a single file to be displayed. You can set a time between <b>No</b> (0) to 60 seconds. When you set <b>No</b> , auto play is disabled.
Effect	You can set the screen effects when changing slides.

- 4 When you have finished making settings, use the     buttons to position the cursor over **OK**, and then press the  button.

The settings are applied.

If you do not want to apply the settings, position the cursor on **Cancel**, and then press the  button.

# Projecting Two Different Images Using Picture in Picture

## Types of Screen that can be Displayed Simultaneously

Two different image sources can be projected, one in the main screen (large screen) and the other in the sub screen (small screen). You can view the sub screen while viewing the main screen.



### Combinations of input sources for Picture in Picture projection

	HDMI1	HDMI2	WirelessHD*	PC	LAN
HDMI1	-	✓	✓	-	-
HDMI2	✓	-	✓	-	-
WirelessHD*	✓	✓	-	-	-
PC	-	-	-	-	-
LAN	-	-	-	-	-

\* EH-TW6700W only.

## Projecting on a Picture in Picture

### Starting and exiting Picture in Picture

Press the **P-in-P** button on the remote control while the projector is projecting.

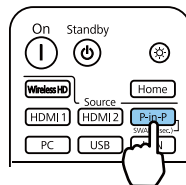

The currently input image is displayed on a Picture in Picture.

Main screen: The current image

Sub screen: The source different from the main screen

Press the **P-in-P** button again to end the Picture in Picture display.

- You may not be able to display 3D images depending on the Picture in Picture requirements.
- You can switch the displays between the main and the sub screen by holding down the **P-in-P** button.
- If the source being input is not supported, nothing is displayed.

## ■ Changing the Picture in Picture settings

Use the **Picture in Picture** menu to change the size or position of the sub screen.

- 1 Press the  button on the remote control while the projector is projecting.

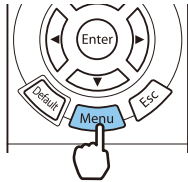

The **Picture in Picture** menu is displayed.

- 2 Make settings for each of the displayed functions.

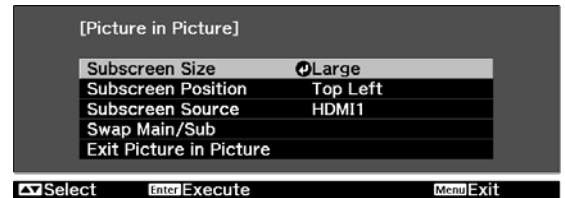

Available functions on the **Picture in Picture** menu

Function	Explanation
Subscreen Size	Selects the sub screen size using <b>Small</b> and <b>Large</b> .
Subscreen Position	Changes the sub screen position using <b>Top Right</b> , <b>Bottom Right</b> , <b>Top Left</b> , and <b>Bottom Left</b> .
Subscreen Source*	Selects which source is displayed as the sub screen.
Swap Main/Sub	Switches the main and sub screens.
Exit Picture in Picture	Exits the Picture in Picture display.

\* EH-TW6700W only.



## Projecting Using Wired LAN (EH-TW6800 Only)

You can send images to your projector through a wired network.

To do this, connect the projector to your network, and then set up your projector and computer for network projection.

You can use EasyMP Multi PC Projection to project images over wired LAN. You can project up to four separate screens from up to 50 computers connected to the network.

Download EasyMP Multi PC Projection from the following Web site.

<http://www.epson.com>

### Selecting Wired Network Settings

Before you can project from computers on your network, you need to select network settings on the projector.



Before making settings, connect a LAN cable to the LAN port, and connect the projector to the wired LAN.

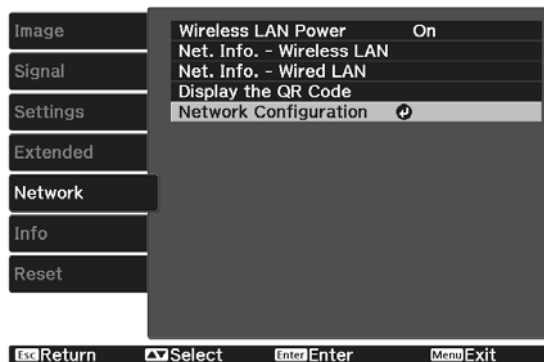

**1** Press the  button to display menus in the order **Network - Network Configuration**.



**2** Select **Basic**, and then set the following as necessary.

- **Projector Name:** Enter a name up to 16 alphanumeric characters long to identify the projector over the network.
- **PJLink Password:** Set a password to use when you control the projector using compatible PJLink software. You can enter up to 32 single-byte alphanumeric characters.
- **Remote Password:** Set a password to use when you operate the projector from a smartphone or a tablet. You can enter up to 8 single-byte alphanumeric characters.
- **Display LAN Info.:** Set the display format for the projector's network information.



Use the displayed keyboard to enter the name, passwords and keyword. Press the  button on the remote control to highlight characters, and then press the  button to enter them.

**3** Select **Wired LAN**, and then press the  button.

- 4 Select the basic options as necessary.
- If your network uses DHCP, set **DHCP** to **On**.
  - If you are not using DHCP, set **DHCP** to **Off**, and then enter the projector's **IP Address**, **Subnet Mask**, and **Gateway Address**.

- 5 When you have finished making settings, select **Complete** and follow the on-screen instructions to save your settings and exit the menus.

- 6 Press the  button on the remote control.

The settings are complete when you see the correct IP address on the LAN standby screen.



To prevent the IP address from being displayed on the LAN standby screen or the Home screen, set **IP Address Display** to **Off**. ➔ **Network - Network Configuration - Wired LAN** [p.98](#)

## Projecting Using Wireless LAN

You can project images from smartphones, tablets, and computers over wireless LAN.

To project over wireless LAN, you need to make wireless network settings for the projector and the connected device in advance.

You can use one of the following methods to project over wireless LAN.

- When using EasyMP Multi PC Projection, you can display up to four separate screens from the projector from up to 50 computers connected to the network.

Download EasyMP Multi PC Projection from the following Web site.

<http://www.epson.com>

- When using Epson iProjection, you can project images from smartphones and tablets.  [p.81](#)

### Selecting Wireless Network Settings Manually

Before you can project from your wireless network, you need to select network settings for the projector.

- 1 Press the  button to display menus in the order **Network - Wireless LAN Power**.

- 2 Use the   buttons to select **On**, and then press the  button.

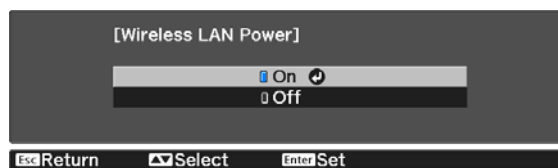



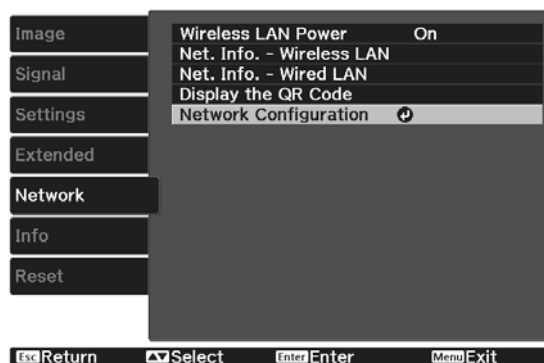



- 3 Select **Network Configuration**, and then press the  button.



**4** Select **Basic**, and then set the following as necessary.

- **Projector Name:** Enter a name up to 16 alphanumeric characters long to identify the projector over the network.
- **PJLink Password:** Set a password to use when you control the projector using compatible PJLink software. You can enter up to 32 single-byte alphanumeric characters.
- **Remote Password:** Set a password to use when you operate the projector from a smartphone or a tablet. You can enter up to single-byte 8 alphanumeric characters.
- **Display LAN Info.:** Set the display format for the projector's network information.

 Use the displayed keyboard to enter the name, passwords and keyword. Press the     buttons on the remote control to highlight characters, and then press the  button to enter them.

**5** Select **Wireless LAN**, and then press the  button.

**6** Select the **Connection Mode** setting.

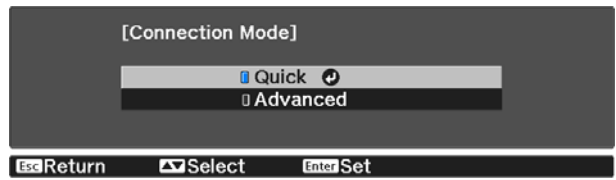

- **Quick:** Lets you connect to multiple smartphones, tablets, or computers directly using wireless communication. When you select **Quick**, go to step 10.
- **Advanced:** Lets you connect to multiple smartphones, tablets, or computers over a wireless network access point. When you select **Advanced**, go to step 7.

**7** Select **Network Configuration - Wireless LAN - Search Access Point**, to select the access point you want to connect to.

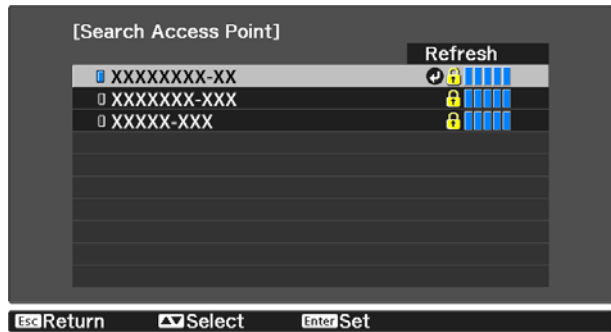

 If you need to assign the SSID manually, select **SSID** to enter the SSID.

8 Assign an IP address to the projector as necessary.

- If your network uses DHCP, select **IP Settings** to set the **DHCP** setting to **On**.
- If you are not using DHCP, select **IP Settings** to set the **DHCP** setting to **Off**, and then enter the projector's **IP Address**, **Subnet Mask**, and **Gateway Address**.



9 When you have finished selecting settings, select **Complete** and then follow the on-screen instructions to save your settings and exit the menus.

10 Press the  button on the remote control. The settings are complete when you see the correct IP address on the LAN standby screen.

When you have finished making wireless settings for your projector, you need to make wireless settings on the connected device. Then start the network software to send images to your projector through a wireless network.

 To prevent the SSID and IP address from being displayed on the LAN standby screen or the Home screen, set **SSID Display** and **IP Address Display** to **Off**. [Network - Network Configuration - Wireless LAN p.97](#)

## Selecting the Computer's Wireless LAN Settings

Before connecting to the projector, select the correct wireless network on your computer.

### Selecting wireless network settings in Windows

1 To access your wireless utility software, double-click the network icon on the Windows taskbar.

2 When connecting in Advanced connection mode, select the network name (SSID) of the network the projector is connecting to.

3 Click **Connect**.

### Selecting wireless network settings in OS X

1 Click the AirPort icon on the menu bar at the top of the screen.

- 2 When connecting in Advanced connection mode, make sure AirPort is turned on and select the network name (SSID) of the network the projector is connecting to.

## Setting Up Wireless Network Security

You can set up security for your projector to use on a wireless network. Set up one of the following security options to match the settings used on your network:

- WPA2 security
- WPA/WPA2 security

- 1 Press the  button to display menus in the order **Network - Network Configuration - Security**.

- 2 Select the security settings to match your network settings.

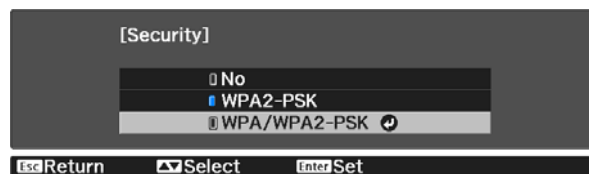



- 3 When you have finished making settings, select **Complete** and follow the on-screen instructions to save your settings and exit the menus.



## Projecting in Epson iProjection

You can display a QR code on the screen and use it to connect a smartphone or tablet using the Epson iProjection app.



- You can download Epson iProjection free of charge from App Store or Google Play. Any fees incurred when communicating with the App Store or Google play are the responsibility of the customer.
- When using Epson iProjection in **Quick** connection mode, we recommend making security settings.  [p.81](#)

- 1 Press the  button to display menus in the order **Network - Wireless LAN Power**.

- 2 Use the   buttons to select **On**, and then press the  button.

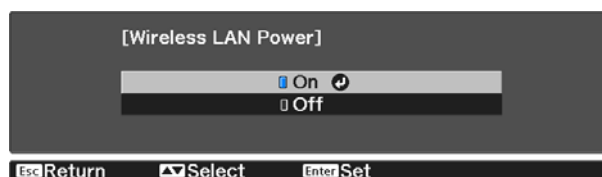



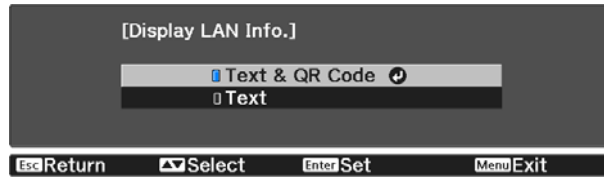

- 3 Display the **Network Configuration - Basic - Display LAN Info**. menu.

4 Use the   buttons to select **Text & QR Code**, and then press the  button.



5 Press the  button on the remote control or select **Display the QR Code** in the projector's **Network** menu to display the QR code.



- If you press the  button, you can also display the QR code from the Home screen.  p.29
- If the projector is already receiving an image signal over the network, the QR code is not displayed even if you press the  button. Select **Display the QR Code** from the **Network** menu to display the QR code.
- To hide the QR code, press the  button.

6 Start Epson iProjection on your smartphone or tablet.

7 Tap  on the application screen.  
The menu is displayed.

8 Tap **Connect** on the menu.  
The projector search screen is displayed.

9 Tap **Read QR code** on the application screen.  
Your camera starts and the preview screen is displayed.



When the projector you want to connect to is displayed in the list on the projector search screen, select the projector and tap **Connect** to connect.

10 Read the projected QR code on your smartphone or tablet.  
Read the code from in front of the screen so that the QR code fits into the guide. If you are too far from the screen, the code may not be read.

When a connection is established, the image from the connected device is displayed. Tap **Photos**, **Documents**, or **Web Page** on the menu, and select the file you want to project.

#### Operating using a smartphone (remote control function)

By using Epson iProjection, you can operate the projector from a smartphone or tablet.

Tap  in Epson iProjection to display the menu.

Tap **Remote** on the menu to display the following screen.



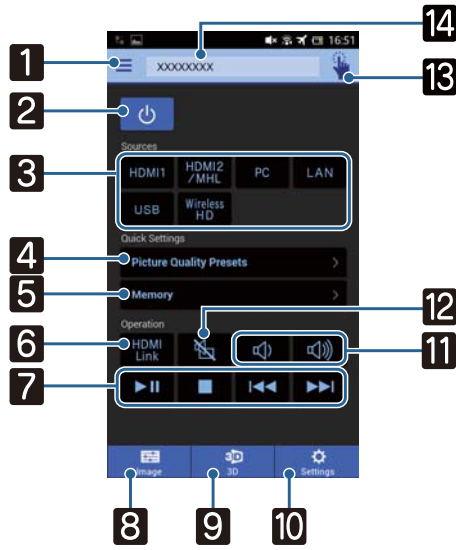

When Remote Password is set, you need to enter the password. Once the password has been recognized, you do not need to enter it from the second time.



Button	Function
<b>1</b>	Displays the menu.
<b>2</b>	Turns the projector on or off.
<b>3</b>	Changes to the image from each input port. <a href="#">p.28</a>
<b>4</b>	Sets the image quality using the on-screen instructions.
<b>5</b>	Saves, loads, erases, or rename a memory. <a href="#">p.47</a>
<b>6</b>	Turns HDMI Link on or off. <a href="#">p.70</a>
<b>7</b>	When HDMI Link is On, you can perform operations such as Play, Stop, Fast Forward, Rewind, Next Chapter, Previous Chapter, and Pause.
<b>8</b>	Sets the <b>Color Mode, Frame Interpolation, Image Enhancement, Color Temp., Gamma, RGBCMY, Power Consumption, and Auto Iris.</b>
<b>9</b>	Sets the <b>3D Display, 3D Format, 2D-to-3D Conversion, 3D Depth, Diagonal Screen Size, and 3D Brightness.</b>
<b>10</b>	Sets the <b>Aspect, Image Processing, Keystone, Picture in Picture, Bluetooth, Reset All Config, Reset Memory, and Test Pattern.</b>
<b>11</b>	Adjusts the volume. For the EH-TW6800, you can adjust the volume when HDMI Link is set to On.
<b>12</b>	Turns the video and audio on or off. <a href="#">p.36</a>



Button		Function
<b>13</b>		Opens the touch pad screen. You can operate the Configuration menu by touching your touch pad.
<b>14</b>	<input type="text" value="XXXXXXX"/> 	Selects the projector you want to control.

# Configuration Menu Functions

## Configuration Menu Operations

On the Configuration menu, you can make adjustments and settings for Signal, Image, and so on.

1 Press the **Menu** button.

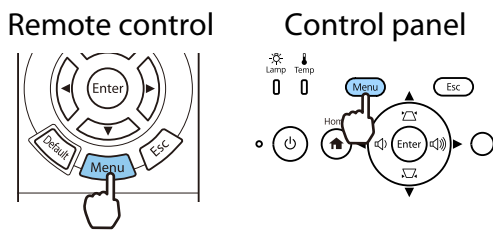

The Configuration menu is displayed.

2 Use the **Up** and **Down** buttons to select the top menu on the left, and then press the **Enter** button to confirm the selection.

When you select the top menu on the left, the sub menu on the right changes.

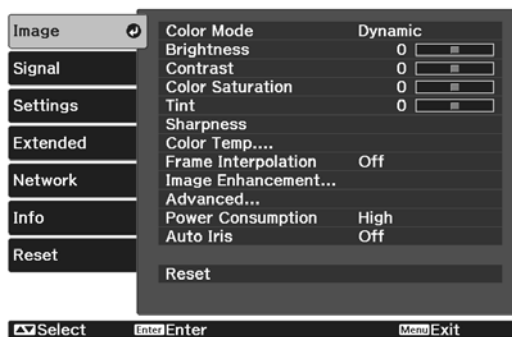

The line at the bottom is a guide for operations.

3 Use the **Up** and **Down** buttons to select the sub menu on the right, and then press the **Enter** button to confirm the selection.

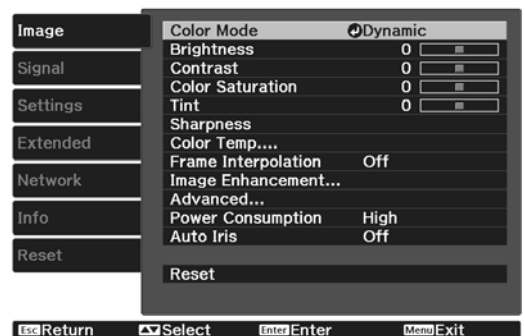

The adjustment screen for the selected function is displayed.

4 Use the **Up**, **Down**, **Left**, and **Right** buttons to adjust the settings.

Ex.) Adjustment bar



Ex.) Choices

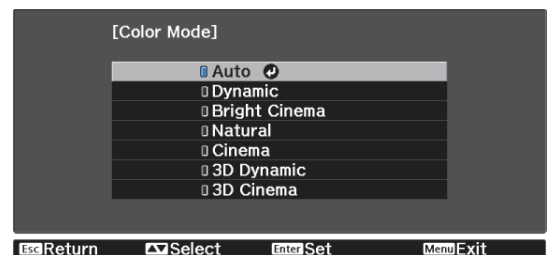

Press the **Enter** button on an item displaying this **Enter** icon to change to the selection screen for that item.

Press the **Esc** button to return to the previous level.

5 Press the **Menu** button to exit the menu.



















For items adjusted using an adjustment bar, such as the brightness level, you can press the  button while the adjustment screen is displayed to return the adjustment value to its default value.

## Configuration Menu Table

If there is no image signal being input, you cannot adjust items related to the **Image** or **Signal** in the Configuration menu. Note that the items displayed for the **Image**, **Signal**, and **Info** vary depending on the image signal being projected.

### Image menu

Function	Menu/Settings	Explanation
Color Mode	Auto, Dynamic, Bright Cinema, Natural, Cinema, 3D Dynamic, 3D Cinema	Select a color mode based on your surroundings and the image you are projecting.  p.37
Brightness		Adjusts the brightness when the image appears too dark.
Contrast		Adjusts the contrast between light and shade in the images. By increasing the contrast, the images become vivid.
Color Saturation		Adjusts the color saturation for the images.
Tint		Adjusts the tint for the images.
Sharpness	Standard, High-band Enhancement, Low-band Enhancement 	Adjusts the image sharpness.
Color Temp.	Color Temp. 	Adjusts the tint for the images. The image is tinted blue for high values, and tinted red for low values.
	Skin Tone 	Adjusts the skin tone. The image becomes greener when set to a positive value and redder when set to a negative value.
	Customized 	Adjusts the offset and gain for each R, G, and B color.
Frame Interpolation*1	Off, Weak, Normal, Strong	Adjusts the smoothness of movement of the image.

Function	Menu/Settings		Explanation	
Image Enhancement*2	Image Preset Mode		Off, Preset 1 to Preset 5	Select the settings prepared in advance as the settings for <b>Noise Reduction</b> , <b>MPEG Noise Reduction</b> , <b>Super-resolution</b> , and <b>Detail Enhancement</b> .
	Noise Reduction			Adjusts the roughness of the image.
	MPEG Noise Reduction			Smooths out rough images in MPEG format.
	Super-resolution		Fine Line Adjust, Soft Focus Detail	Adjusts the amount of enhancement for complicated images and backgrounds.
	Detail Enhancement		Strength*4, Range*4 	Creates a more emphatic texture and material feel of the image.
Advanced	Gamma		2, 1, 0, -1, -2, Customized*3, Reset	Performs gamma adjustments. You can select a raw value or adjust the gamma while viewing the image or graph.  p.45
	RGBCMY	R/G/B/C/M/Y	Hue, Saturation, Brightness 	Adjusts the hue, saturation, and brightness for each R, G, B, C, M, and Y color.  p.43
	Deinterlacing		Off, Video, Film/Auto	(This can only be set when <b>Image Processing</b> is set to <b>Fine</b> or when receiving 480i, 576i, or 1080i signal input from the HDMI1, or HDMI2 ports or from WirelessHD.) Converts the signal from interlaced (i) to progressive (p) using a method appropriate for the image signal. <ul style="list-style-type: none"> <li>• <b>Off</b>: This is ideal for dynamic motion images.</li> <li>• <b>Video</b>: This is ideal for viewing general video images.</li> <li>• <b>Film/Auto</b>: Performs the optimal conversion for film, CG, or animation input signals.</li> </ul>
	EPSON Super White*1		On, Off	Set this to <b>On</b> if you are experiencing bright over exposure of whites in your image. When set to <b>On</b> , <b>HDMI Video Range</b> settings are disabled.
Power Consumption	High, Medium, ECO		You can set the lamp brightness to one of three settings. Select <b>ECO</b> if the images being projected are too bright. When <b>ECO</b> is selected, power consumption during projection decreases, and fan rotation noise is reduced.	
Auto Iris	Off, Normal, High Speed		You can change the luminance adjustment tracking for changes in brightness in the displayed image.  p.41	
Reset	Yes, No		Resets the adjustment values of <b>Image</b> set in the current Color Mode to the default settings.	

\*1 Only when an HDMI1 or HDMI2 image signal is being input.







\*2 Only when an HDMI1, HDMI2, or PC image signal is being input.

\*3 Settings are saved for each type of input source or Color Mode.

\*4 EH-TW6800 only.

■ Signal menu

The Signal menu cannot be set when a LAN image signal is being input.

Function	Menu/Settings		Explanation
3D Setup* <sup>1</sup>	3D Display	Auto, 3D, 2D	To view 3D images, set this to <b>Auto</b> or <b>3D</b> .  <a href="#">p.49</a>
	3D Format	Side by Side, Top and Bottom	Sets the 3D format for the input signal.
	2D-to-3D Conversion	Off, Weak, Medium, Strong	Converts 2D images to 3D images.
	3D Depth	-10 10	Sets the depth for the 3D image.
	Diagonal Screen Size	60 300	Sets the projection size for the 3D image. By matching this to the actual size, you can achieve the optimum 3D effect.
	3D Brightness	Low, Medium, High	Sets the brightness for the 3D image.
	Inverse 3D Glasses	Yes, No	Reverses the synchronization timing for the left/right shutters on the 3D Glasses and the left/right images. Enable this function if the 3D effect is not displayed correctly.
	3D Viewing Notice	On, Off	Turns the notice that appears when viewing 3D content on or off.
Aspect* <sup>2</sup>	Auto* <sup>1</sup> , Normal, Full, Zoom, Anamorphic Wide* <sup>4</sup> , Horiz. Squeeze* <sup>4</sup>		Selects the aspect mode.  <a href="#">p.38</a>
Tracking* <sup>2</sup> * <sup>3</sup>	Varies depending on the input signal.		Adjusts computer images when vertical stripes appear in the images.
Sync.* <sup>2</sup> * <sup>3</sup>	0 31		Adjusts computer images when flickering, fuzziness, or interference appear in the images. <ul style="list-style-type: none"> <li>Adjusting the <b>Brightness</b>, <b>Contrast</b>, or <b>Sharpness</b> may cause flickering or fuzziness.</li> <li>When adjusting <b>Sync.</b> after adjusting the <b>Tracking</b>, you can create a more vivid image.</li> </ul>
Position* <sup>2</sup> * <sup>3</sup>	   		Adjusts the display position up, down, left, and right when a part of the image is missing so that the whole image is projected.
Auto Setup* <sup>3</sup>	On, Off		Sets whether or not to automatically adjust the image whenever the input signal is changed. When enabled, the Tracking, Position, and Sync. are automatically configured.

Function	Menu/Settings		Explanation
Overscan <sup>*1 *2</sup>	Auto, Off, 4%, and 8%		<p>Changes the output image ratio (the range of the projected image).</p> <ul style="list-style-type: none"> <li>• <b>Off, 4%, 8%:</b> Sets the range of the image. <b>Off</b> projects all ranges. Depending on the image signal, you may notice noise at the top and bottom of the image.</li> <li>• <b>Auto:</b> Automatically sets to <b>Off</b> or <b>8%</b> depending on the input signal.</li> </ul>
Advanced	HDMI Video Range <sup>*1 *2</sup>	Auto, Normal, Expanded	<p>(This can only be set when <b>EPSON Super White</b> is set to <b>Off</b>.)</p> <p>When set to <b>Auto</b>, the video level for the DVD input signal to the HDMI1 or HDMI2 ports is automatically detected and set.</p> <p>If you experience under or overexposure when set to <b>Auto</b>, set the video level of the projector to match that of the DVD/Blu-ray disc player's video level. Your player may be set to Normal or Expand.</p>
	Image Processing <sup>*1 *3</sup>	Fine, Fast	Improves the response speed for images projected at high-speed, such as games.
Reset	Yes, No		Resets all <b>Signal</b> settings except for <b>Diagonal Screen Size, 3D Viewing Notice, and Aspect</b> .



\*1 Only when an HDMI1, HDMI2, WirelessHD image signal is being input.



\*2 Settings are saved for each type of input source or signal.









\*3 Only when a PC image signal is being input.

\*4 EH-TW6800 only.

 Settings menu

Function	Menu/Settings			Explanation
Keystone	H/V-Keystone	V-Keystone	-60 60	<p>Corrects the shape of the projected image that is an uneven rectangle.</p> <ul style="list-style-type: none"> <li>• H/V-Keystone: Manually corrects horizontal and vertical distortions.  p.34</li> <li>• Quick Corner: Select this to correct image shape and alignment using an on-screen display.  p.34</li> </ul>
		H-Keystone	-60 60	
	Quick Corner	-		
Picture in Picture	-			<p>Starts the Picture in Picture display.  p.74</p>
Audio <sup>*1</sup>	Volume	Volume	0 40	<p>Adjusts the volume.</p> <p>Sets whether or not to invert the left and right audio output channels. Set to <b>On</b> when the projector is suspended from a ceiling and is using the internal speakers.</p>
	Inverse Audio <sup>*2</sup>	On, Off		

Function	Menu/Settings		Explanation
HDMI Link	Device Connections	-	Displays a list of devices connected to the HDMI1 or HDMI2 ports, or to WirelessHD*3.
	HDMI Link	On, Off	Enables or disables the HDMI Link function.
	Audio Out Device	Projector, AV System, WiHD Transmitter (Optical)*3, WiHD Transmitter (HDMI)*3	Selects which device outputs audio.  <a href="#">p.70</a>
	Power On Link	Off, Bidirectional, Device -> PJ, PJ -> Device	Sets the link function when the power is turned on. <ul style="list-style-type: none"> <li>• When linking operations to the connected device and turning on the projector, select <b>Bidirectional</b> or <b>Device -&gt; PJ</b>.</li> <li>• When linking power on for the projector to the connected device, select <b>Bidirectional</b> or <b>PJ -&gt; Device</b>.</li> </ul>
	Power Off Link	On, Off	Sets whether or not to power off connected devices when the projector is turned off.
	Link Buffer	On, Off	If HDMI Link is not working correctly, you may be able to improve it by changing the settings.
WirelessHD*3	Connected Device	-	Displays the available WirelessHD device that can be connected.
	WirelessHD	On, Off	Enables or disables the WirelessHD function.
	Video Reception		Indicates the connection status with the WirelessHD Transmitter. While connected, Transmitter detected is displayed.
	Reset	Yes, No	Resets <b>WirelessHD</b> settings to their default settings. Note that even if you reset the projector, the WirelessHD Transmitter settings are not reset. To reset the WirelessHD Transmitter, press the Setup button on the base for 5 seconds or more.  <a href="#">p.57</a>

Function	Menu/Settings		Explanation
Bluetooth	Search Bluetooth Device	-	Searches for available Bluetooth devices and displays them as a list.
	Bluetooth Audio	On, Off	<p>Enables or disables audio output from Bluetooth audio devices. Setup cannot be performed in the following cases.</p> <ul style="list-style-type: none"> <li>• When the source is LAN or USB</li> <li>• When <b>Audio Out Device</b> from the <b>HDMI Link</b> menu is set to <b>AV System, WiHD Transmitter (Optical),</b> or <b>WiHD Transmitter (HDMI)</b></li> </ul>
Lock Setting	Child Lock	On, Off	<p>This locks the  button on the projector's control panel to prevent children from turning on the projector by accident. You can turn on the power when locked by holding down the  button for approximately three seconds. You can still turn off the device using the  button, or perform operations with the remote control as usual.</p> <p>If changed, this setting is enabled after you power off the projector and the cool-down process is complete. Note that even if <b>Child Lock</b> is set to <b>On</b>, the projector still turns on when the power cord is connected if <b>Direct Power On</b> is set to <b>On</b>.</p>
	Control Panel Lock	Full Lock, Partial Lock, Off	<p><b>Full Lock:</b> Disables all of the projector's buttons.</p> <p><b>Partial Lock:</b> Disables all of the projector's buttons except for the  button.</p> <p> is displayed on the screen if buttons are pressed while the projector is locked. To unlock, press and hold the  button on the control panel for at least 7 seconds.</p> <p>If changed, this setting is enabled once you close the Configuration menu.</p>
User Button	Fine/Fast, 3D Display, 2D-to-3D Conversion, Brightness Control, Info, Display the QR Code		<p>Select a Configuration menu item to assign to the  button on the remote control. By pressing the  button, the assigned menu item selection/adjustment screen is displayed, allowing you to make one-touch settings/adjustments.</p>



Function	Menu/Settings		Explanation
Memory	Load Memory	Memory1 to Memory10	Loads the settings saved in Save Memory to adjust the image.
	Save Memory	Memory1 to Memory10	Saves the settings made in <b>Image</b> to a memory.
	Erase Memory	Memory1 to Memory10	Erases a saved memory.
	Rename Memory	Memory1 to Memory10, Default, DVD, VCR, SDTV, HDTV, Cinema, Sports, Music, Anime, Game, Customized	Changes the saved memory name.
Reset	Yes, No		Resets all the items in <b>Settings</b> except for <b>Inverse Audio</b> , <b>Audio Out Device</b> , <b>Power On Link</b> , <b>Power Off Link</b> , <b>User Button</b> , and <b>Memory</b> .



\*1 This can only be set when **Audio Out Device** is set to **Projector** from the **HDMI Link** menu, or **Bluetooth Audio** is set to **Off** from the **Bluetooth** menu. EH-TW6700W/EH-TW6700/EH-TW6300 only.



\*2 EH-TW6800/EH-TW6700W/EH-TW6700 only.

\*3 EH-TW6700W only.

Extended menu

Function	Menu/Settings		Explanation
Home Screen	Home Screen Auto Disp.	On, Off	Selects whether or not to display the Home screen automatically when the projector turns on. The Home screen is not displayed when the selected source has an image signal when the projector turns on.
	Custom Function 1	Power Consumption, Auto Iris, Keystone, Info	Select the function assigned to the Home screen.
	Custom Function 2		

Function	Menu/Settings		Explanation	
Display	Messages	On, Off	<p>Sets whether or not to display the following messages (On or Off).</p> <ul style="list-style-type: none"> <li>• Item names for image signals, color modes, and aspect ratios.</li> <li>• If the internal temperature is rising when no image signal is being input or an unsupported signal is detected.</li> </ul>	
	Display Background	Black, Blue, Logo	Selects the screen status when no image signal is being input.	
	Startup Screen	On, Off	Sets whether or not to show a startup screen when projection begins (On or Off). If changed, this setting is enabled after you power off the projector and the cool-down process is complete.	
	Standby Confirmation	On, Off	Sets whether or not to display a standby confirmation message (On or Off).  <a href="#">p.30</a>	
	Panel Alignment	-	 <a href="#">p.95</a>	
	Color Uniformity*	Color Uniformity	On, Off	Enables or disables Color Uniformity.
		Adjustment Level		There are eight levels from white, through gray, and up to black. You can adjust each level individually.
		Start Adjustments	Red, Green, Blue	Starts making Color Uniformity adjustments.
Reset		Yes, No	Resets all adjustments and settings for Color Uniformity to their default values.	
Projection	Front, Front/Ceiling, Rear, Rear/Ceiling		Change this setting depending on how the projector is installed.	

Function	Menu/Settings		Explanation
Operation	Direct Power On	On, Off	You can set up the projector so that projection starts as soon as the power cord is plugged in without any button operations. Note that when this is set to <b>On</b> , projection starts if power is restored after a blackout or other power outage and the power cord is still plugged into the projector.
	Sleep Mode	On, Off	If the set time is exceeded and no signal is input, the projector is automatically turned off and enters standby mode. When in standby mode, press the  button on the remote control or the  button on the control panel to start projection.
	Sleep Mode Timer	1:30	Sets the interval for <b>Sleep Mode</b> .
	Illumination	On, Off	Set this to <b>Off</b> if the light from the indicators on the control panel bother you when watching a movie in a dark room.  When set to <b>Off</b> , the WiHD transmitter indicator also turns off while standing by.
	Trigger Out*	Off, Power, Anamorphic Wide	Set the Trigger Out function to communicate the projector's power on status and so on to external devices. When set to <b>Off</b> , no voltage is output from the Trigger Out port. When set to <b>Power</b> , voltage is output from the Trigger Out port when the projector is on. If you change this setting, the new setting will take effect the next time you turn the projector on.  For <b>Anamorphic Wide</b> , when the projector is on and <b>Aspect</b> is set to <b>Anamorphic Wide</b> or <b>Horiz. Squeeze</b> , voltage is output from the Trigger Out port.  If you change this setting, the new setting will take effect the next time you turn the projector on.
	High Altitude Mode	On, Off	Set this to <b>On</b> if you are using the projector above an altitude of 1500 meters.
	Auto Source Search	On, Off	Set to <b>On</b> to detect the input signal automatically and project images when there is no input signal.
Standby Mode	Communication Off, Communication On		<b>Communication On</b> indicates that the projector can be monitored over a network when the projector is in standby mode.
Language	-		Selects the display language.

Function	Menu/Settings	Explanation
Reset	Yes, No	Resets all items in <b>Extended</b> except for <b>Memory, Projection, High Altitude Mode, Auto Source Search, Standby Mode, and Language.</b>

\* EH-TW6800 only.

Panel Alignment menu

Menu/Settings		Explanation	
Panel Alignment	Panel Alignment	On, Off Enables or disables Panel Alignment.	
	Select Color	R, B Select the color to correct.	
	Pattern Color	R/G/B, R/G, G/B Select the pattern used for correction.	
	Start Adjustments	- Starts Panel Alignment.  <a href="#">p.123</a>	
	Memory	Load Panel Alignment	Memory1, Memory2, Memory3 Loads settings saved using the Save Panel Alignment function.
		Save Panel Alignment	Memory1, Memory2, Memory3 Saves the settings made in Panel Alignment to a memory.
		Erase Panel Alignment	Memory1, Memory2, Memory3 Erases memories registered using the Panel Alignment function.
		Rename Panel Alignment	Memory1, Memory2, Memory3 Renames Panel Alignment memories.
Reset	Yes, No Resets the correction value.		

 Network menu

Function	Menu/Settings	Explanation
Wireless LAN Power	On, Off	Sets whether or not to use a wireless LAN ( <b>On</b> or <b>Off</b> ).
Net. Info. - Wireless LAN	-	Displays the following network settings. <ul style="list-style-type: none"> <li>• Connection Mode</li> <li>• Wireless LAN system</li> <li>• Antenna Level</li> <li>• Projector Name</li> <li>• SSID</li> <li>• DHCP</li> <li>• IP Address</li> <li>• Subnet Mask</li> <li>• Gateway Address</li> <li>• MAC Address</li> <li>• Region Code</li> </ul>

Function	Menu/Settings	Explanation
Net. Info. - Wired LAN*	-	Displays the following network setting status information. <ul style="list-style-type: none"> <li>• Projector Name</li> <li>• DHCP</li> <li>• IP Address</li> <li>• Subnet Mask</li> <li>• Gateway Address</li> <li>• MAC Address</li> </ul>
Display the QR Code	-	Displays network information for the projector with a QR code.
Network Configuration	-	Displays the screen to set the network.  p.97

\* EH-TW6800 only.

### Notes on operating the Network menu

Basic operations are made in the same way as when using the Configuration menu.

However, be sure to select the **Complete** menu to save your settings when done.



**Yes:** Saves the settings and exits the Network menu.

**No:** Exits the Network menu without saving the settings.

**Cancel:** Continues displaying the Network menu.

### Soft Keyboard Operations

In the Network menu, the soft keyboard appears when you need to enter numbers and characters.

Use the on the remote control or (or ) on the control panel to select the desired key, and then press the button to enter.

Press **Finish** to confirm your input, or **Cancel** to cancel your input.



**CAPS** key: Switches between uppercase and lowercase letters.



**SYM1/2** key: Switches the symbol keys.

Basic menu

Function	Menu/Settings	Explanation
Projector Name	Up to 16 alphanumeric characters	Enter a name to identify the projector over a network.
PJLink Password*	Up to 32 alphanumeric characters	Set a password to use when you control the projector using compatible PJLink software.  <a href="#">p.127</a>
Remote Password	Up to 8 alphanumeric characters	Set a password to use when you operate the projector from a smartphone or a tablet.
Display LAN Info.	Text & QR Code, Text	Set the display format for the projector's network information.

\* EH-TW6800 only.

Wireless LAN menu

Function	Menu/Settings	Explanation
Connection Mode	Quick, Advanced	Determines how the wireless LAN is connected. <b>Quick:</b> Lets you connect to multiple smartphones, tablets, or computers directly using wireless communication. Use EasyMP Multi PC Projection to connect in this connection mode. The projector acts as an easy access point. (We recommend limiting the number of devices to six or less to maintain the projection performance.) <b>Advanced:</b> Lets you connect to multiple smartphones, tablets, or computers over a wireless network access point.
Channel	1ch, 6ch, 11ch	(This can only be set when <b>Connection Mode</b> is set to <b>Quick</b> .) Select the frequency bandwidth used by the wireless LAN.
SSID	Up to 32 alphanumeric characters	(This can only be set when <b>Connection Mode</b> is set to <b>Advanced</b> .) Enter an SSID. When an SSID is provided for the wireless LAN system in which the projector participates, enter the SSID.
Search Access Point	To Search View	(This can only be selected when <b>Connection Mode</b> is set to <b>Advanced</b> .) Search for available wireless network access points.  indicates currently connected access points.  indicates the access points where security is set. If you select an access point which has security, Security menu appears.  <a href="#">p.98</a>

Function	Menu/Settings	Explanation
IP Settings (This can only be set when <b>Connection Mode</b> is set to <b>Advanced</b> .)	DHCP	Sets whether or not to use DHCP (On or Off). If this is set to <b>On</b> , you cannot set any more addresses.
	IP Address	Inputs the IP address for the projector. The following IP addresses cannot be used. 0.0.0.0, 127.x.x.x, 224.0.0.0 to 255.255.255.255 (where x is a number from 0 to 255)
	Subnet Mask	Enter the projector's subnet mask. The following subnet masks cannot be used. 0.0.0.0 255.255.255.255
	Gateway Address	Inputs the gateway IP address of the projector. The following gateway addresses cannot be used. 0.0.0.0, 127.x.x.x, 224.0.0.0 to 255.255.255.255 (where x is a number from 0 to 255)
SSID Display	On, Off	Sets whether or not to display the SSID on the LAN Standby screen and the Home screen (On or Off).
IP Address Display	On, Off	Sets whether or not to display the IP address on the LAN Standby screen and the Home screen (On or Off).

### Security menu

Function	Menu/Settings	Explanation
Security	No, WPA2-PSK, WPA/WPA2-PSK	Sets the security. In <b>Quick</b> , <b>WPA2-PSK</b> is selectable. In <b>Advanced</b> , <b>WPA2-PSK/WPA/WPA2-PSK</b> is selectable.
Passphrase	From 8 to 32 single-byte alphanumeric characters	Inputs the passphrase. It is recommended to change the passphrase periodically for the purpose of security.

### Wired LAN menu (EH-TW6800 only)

Function	Menu/Settings	Explanation
DHCP	On, Off	Set whether or not ( <b>On/Off</b> ) to use DHCP. If this is set to <b>On</b> , you cannot set any more addresses.
IP Address	0 to 255 characters	Enter the IP address assigned to the projector. The following IP addresses cannot be used. 0.0.0.0, 127.x.x.x, 224.0.0.0 to 255.255.255.255 (where x is a number from 0 to 255)
Subnet Mask	0 to 255 characters	Enter the projector's subnet mask. The following subnet masks cannot be used. 0.0.0.0 255.255.255.255
Gateway Address	0 to 255 characters	Enter the projector's gateway IP address. The following gateway addresses cannot be used. 0.0.0.0, 127.x.x.x, 224.0.0.0 to 255.255.255.255 (where x is a number from 0 to 255)
IP Address Display	On, Off	Set to Off to prevent the IP address from being displayed on the <b>Net. Info. - Wired LAN</b> screen.

Others menu (EH-TW6800 only)

Function	Menu/Settings	Explanation
AMX Device Discovery	On, Off	When you want to allow the projector to be detected by AMX Device Discovery, set this to <b>On</b> . Set this to <b>Off</b> if you are not connected to an environment controlled by a controller from AMX or AMX Device Discovery.
Control4 SDDP	On, Off	When you want to allow the projector to be detected by Control4 SDDP, set this to <b>On</b> . Set this to <b>Off</b> if you are not connected to an environment controlled by a controller from Control4 or Control4 SDDP.

Reset menu

Function	Explanation
Reset network settings.	You can reset all adjustment values for <b>Network</b> to their default settings.

Info menu

Function	Menu/Settings	Explanation
Projector Info	Lamp Hours	Displays the cumulative lamp operating time*.
	Source	Displays the current input source.
	Input Signal	Displays the input signal setting of the current input source.
	Resolution	Displays the resolution.
	Scan Mode	Displays the scan mode.
	Refresh Rate	Displays the refresh rate.
	3D Format	Displays the 3D format of the signal input during 3D projection (Frame Packing, Side by Side, or Top and Bottom).
	Sync Info	Displays the image signal information. This information may be needed if service is required.
	Color Depth	Displays the color depth and color difference.
	Status	This is information about errors that have occurred on the projector. This information may be needed if service is required.
	Serial Number	Displays the projector's serial number.
	Event ID	The application error log appears.  <a href="#">p.114</a>
Version	Main	Displays the firmware version of the projector.
	Video2	

\* The cumulative use time is displayed as "0H" for the first 10 hours. 10 hours and above is displayed as "10H", "11H", and so on.







### Reset menu

---

Function	Explanation
Reset Lamp Hours	Resets the cumulative lamp hours use time to <b>0 H</b> . Reset when you replace the lamp.
Reset Memory	Resets all items for <b>Memory</b> to their default settings.
Reset All Config	Resets all items in the Configuration menu to their default settings. The following adjustment values are not reset to their defaults: <b>Memory, Panel Alignment, Color Uniformity, Lamp Hours, Language, and Network Settings.</b>

# Problem Solving

## Reading the Indicators



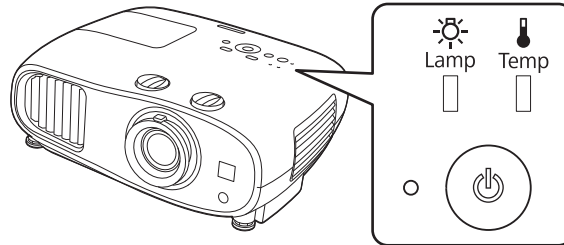









You can check the status of the projector from the flashing and lit ,  (operation indicator),  and  on the control panel.











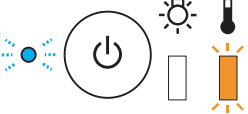
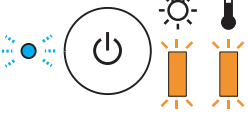

Refer to the following table to check the projector's status and how to remedy problems shown by the indicators.

### Indicator status during an error/warning

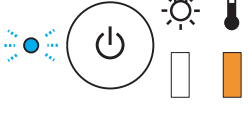





 : Lit  : Flashing  : Status maintained  : Off

Indicators	Status	Remedy
     (blue)/(orange)	Replace Lamp	It is time to replace your lamp. Replace the lamp with a new lamp as soon as possible.  <a href="#">p.120</a> The lamp may explode if you continue to use it in this status.
     (blue)/(orange)	High Temp Warning	You can continue projecting. If the temperature rises too high again, projection stops automatically. <ul style="list-style-type: none"> <li>• If the projector is installed next to a wall, make sure there is at least 20 cm between the wall and the projector's exhaust vent.</li> <li>• If the air filter is clogged, clean it.  <a href="#">p.116</a></li> </ul>

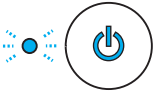

Indicators	Status	Remedy
 (blue)/(orange)	Internal Error	The projector has malfunctioned. Remove the power plug from the electrical outlet, and contact your local dealer or the nearest Epson repair center.  <a href="#">Epson Projector Contact List</a>
 (blue)/(orange)	Fan Error Sensor Error	
 (blue)/(orange)	Auto Iris Error	
 (blue)/(orange)	Power Err. (Ballast)	
 (blue)/(orange)	Lamp Error Lamp Failure	There is a problem with the lamp, or it failed to turn on. <ul style="list-style-type: none"> <li>• Disconnect the power cord, and then check if the lamp is cracked.  <a href="#">p.120</a>                              If it is not cracked, reinstall the lamp and turn on the power. If reinstalling the lamp does not fix the problem, or if the lamp is cracked, remove the power plug from the electrical outlet, and contact your local dealer or the nearest Epson repair center.  <a href="#">Epson Projector Contact List</a></li> <li>• Check that the lamp cover has been properly closed.</li> </ul>
 (blue)/(orange)	High Temp Error (Overheating)	The internal temperature is too high. <ul style="list-style-type: none"> <li>• The lamp turns off automatically and projection stops. Wait for about five minutes. When the fan has stopped, disconnect the power cord.</li> <li>• If the projector is installed next to a wall, make sure there is at least 20 cm between the wall and the projector's exhaust vent.</li> <li>• If the air filter is clogged, clean it.  <a href="#">p.116</a></li> <li>• If turning the power back on does not clear the problem, stop using the projector and remove the power plug from the electrical outlet. Contact your local dealer or the nearest Epson repair center.  <a href="#">Epson Projector Contact List</a></li> <li>• When using at an altitude of 1500 m or more, set <b>High Altitude Mode</b> to <b>On</b>.  <a href="#">Extended - Operation - High Altitude Mode</a> <a href="#">p.92</a></li> </ul>

 Indicator status during normal operation

 : Lit  : Flashing  : Off

Indicators	Status	Remedy
	Standby condition	When you press the  button on the remote control, or the  button on the control panel, projection starts after a short wait.
 (blue)	Warm-up in progress	Warm-up time is about 30 seconds. The power-off operation is disabled while the projector is warming-up.
	Cool-down in progress	All operations are disabled while the projector is cooling-down. The projector enters standby condition when cool-down is complete. If for any reason the power cord is disconnected during cool-down, wait until the lamp has cooled down sufficiently (about 10 minutes), reconnect the power cord, and then press the  button on the remote control, or the  button on the control panel.
 (blue)	Projection in progress	The projector is operating normally.



- Under normal operating conditions, the  and  indicators are off.
- When the **Illumination** function is set to **Off**, all indicators are off under normal projection conditions.  
 **Extended - Operation - Illumination** [p.92](#)

## When the Indicators Provide No Help

### Check the problem





Check the following table to see if your problem is mentioned, and go to the appropriate page for information on handling the problem.

	Problem	Page
Problems relating to images	No images appear. Projection does not start, the projection area is completely black, or the projection area is completely blue.	p.105
	Moving images being projected from a computer are not projected.	p.105
	" <b>Not supported</b> " is displayed	p.105
	" <b>No Signal</b> " is displayed	p.106
	Keystone distortion of projected image	p.106
	Images are fuzzy or out of focus.	p.106
	Interference or distortion appears in the images.	p.106
	The image is truncated (large) or small, or only a part of the image is projected.	p.107
	Image colors are not right. The whole image appears purplish or greenish, images are black & white, or colors appear dull.*	p.107
	Images appear dark.	p.107
	Projection stops automatically.	p.108
	Slideshow does not start	p.108
	Sound problems	No audio, or the audio is too low
Problems when projection starts	The projector does not turn on.	p.109
Problems with the remote control	The remote control does not respond.	p.109
Problems with the control panel	Cannot make settings on the control panel.	p.109
Problems with 3D	Cannot project correctly in 3D.	p.110
Problems with HDMI	HDMI Link does not function.	p.110
	The device name is not displayed under device connections.	p.111
Bluetooth device problems	Cannot Connect Bluetooth Device	p.111
	The audio and connection for the Bluetooth device disconnects	p.111
Problems with WirelessHD	Cannot project WirelessHD images.	p.112
	Interference, distortion, or interruption appear in WirelessHD.	p.112
	Half of the image on the left or right stops projecting or the image is doubled up.	p.113
Network problems	Cannot access the network via wireless LAN.	p.113
	The image contains static during network projection.	p.113

\* Because color reproduction differs between monitors and computer LCD screens, the image projected by the projector and the color tones displayed on the monitor may not match, however this is not a fault.

■ Problems relating to images



No images appear

Check	Remedy
Is the projector turned on?	Press the  button on the remote control or the  button on the control panel.
Is the power cord connected?	Connect the power cord.
Are the indicators switched off?	Disconnect and then reconnect the projector's power cord. Check that pressing the power button after connection supplies the projector with power.
Is an image signal being input?	Check that the connected device is turned on. When <b>Messages</b> is set to <b>On</b> from the Configuration menu, image signal messages are displayed.  <b>Extended - Display - Messages</b> p.92
Has the power to the AV amplifier been disconnected?	If an AV amplifier is connected, check the AV amplifier's power supply.
Is an image signal being sent from the device?	Check that an image signal is being sent from the connected device.
Are the Configuration menu settings correct?	Reset all of the settings.  <b>Reset - Reset All Config</b> p.100
(Only when projecting computer image signals) Was the connection made while the power of the projector or the computer was already turned on?	If the connection is made while the power is already turned on, the Fn key (Function key) that changes the computer's image signal to external output may not work. Turn off the power for the computer and the projector and then turn it back on again.



Moving images are not displayed

Check	Remedy
(Only when projecting computer image signals) Is the computer's image signal set to external output and to output to the LCD monitor at the same time?	Depending on the computer's specifications, moving images may not be displayed when the computer is set to external output and to the LCD monitor output at the same time. Change it so that the image signal is set to external output only. For the computer's specifications, see the documentation supplied with the computer.

"Not supported" is displayed

Check	Remedy
(Only when projecting computer image signals) Do the image signal's frequency and resolution correspond to the mode?	Check the image signal being input in <b>Resolution</b> from the Configuration menu, and check that it corresponds to the projector's resolution.  <b>Info - Projector Info</b> p.99  p.129



**"No Signal"** is displayed

Check	Remedy
Are the cables connected correctly?	Check that all the cables required for projection are securely connected.  <a href="#">p.20</a>
Is the correct image input port selected?	Switch the image with the source buttons on the remote control.  <a href="#">p.28</a>
Is the connected device turned on?	Turn on the device.
(Only when projecting computer image signals) Are the image signals being output to the projector?	Change it so that the image signal is set to external output, and not just the computer's LCD monitor. For some models, when the image signals are output externally, they no longer appear on the LCD monitor. For the computer's specifications, see the documentation supplied with the computer.  If the connection is made while the power of the projector or the computer is already turned on, the Fn key (Function key) that changes the computer's image signal to external output may not work. Turn the power for the computer and the projector off and then back on again.

Keystone distortion of projected image

Check	Remedy
Is keystone distortion adjusted within the correction range?	If projecting the image from outside of the correctable range, you may not be able to correct the keystone distortion completely. Install the projector horizontally in front of the screen as far as possible, and then adjust the projection position using lens shift.  <a href="#">p.15</a>

Images are fuzzy or out of focus

Check	Remedy
Has the focus been adjusted?	Adjust the focus.  <a href="#">p.31</a>
Is the lens cap attached?	Remove the lens cap.
Is the projector at the correct distance?	Check the recommended projection range.  <a href="#">p.17</a>
Has condensation formed on the lens?	If the projector is suddenly taken from a cold environment to a warm environment, or if sudden ambient temperature changes occur, condensation may form on the surface of the lens, and this may cause the images to appear fuzzy. Set the projector up in the room about one hour before it is used. If the projector is wet from condensation, turn off the projector, disconnect the power cord, and leave it for a while.

Interference or distortion appear in images

Check	Remedy
Are the cables connected correctly?	Check that all the cables required for projection are securely connected.  <a href="#">p.20</a>

Check	Remedy
Is an extension cable being used?	If an extension cable is used, electrical interference may affect the signals.
(Only when projecting computer image signals) Are the <b>Sync.</b> and <b>Tracking</b> settings adjusted correctly?	The projector uses automatic adjustment functions to project at the optimum status. However, depending on the signal, some may not be adjusted correctly even after performing self corrections. If this happens, adjust the <b>Tracking</b> and <b>Sync.</b> settings from the Configuration menu. 🖱️ <b>Signal - Tracking/Sync.</b> p.88
(Only when projecting computer image signals) Is the correct resolution selected?	Set the computer so that the signals being output are compatible with the projector. 🖱️ p.129

Part of the image is truncated (large) or small

Check	Remedy
Is the correct <b>Aspect</b> selected?	Select the aspect mode to match the input signal in <b>Aspect</b> from the Configuration menu. 🖱️ <b>Signal - Aspect</b> p.88
Is the image <b>Position</b> adjusted correctly?	Adjust the <b>Position</b> setting from the Configuration menu. 🖱️ <b>Signal - Position</b> p.88
(Only when projecting computer image signals) Is the correct resolution selected?	Set the computer so that the signals being output are compatible with the projector. 🖱️ p.129

Image colors are not right

Check	Remedy
Are the cables connected correctly?	Check that all the cables required for projection are securely connected. 🖱️ p.20 For the PC port, make sure the connector is the same color as the cable port. 🖱️ p.20
Is the contrast adjusted correctly?	Adjust the <b>Contrast</b> setting from the Configuration menu. 🖱️ <b>Image - Contrast</b> p.86
Is the color adjusted correctly?	Adjust the <b>Advanced</b> setting from the Configuration menu. 🖱️ <b>Image - Advanced</b> p.86
(Only when projecting images from a video device) Are the color saturation and tint adjusted correctly?	Adjust the <b>Color Saturation</b> and <b>Tint</b> settings from the Configuration menu. 🖱️ <b>Image - Color Saturation/Tint</b> p.86

Images appear dark

Check	Remedy
Is the image brightness set correctly?	Adjust the <b>Brightness</b> setting from the Configuration menu. 🖱️ <b>Image - Brightness</b> p.86
Is the contrast adjusted correctly?	Adjust the <b>Contrast</b> setting from the Configuration menu. 🖱️ <b>Image - Contrast</b> p.86



Check	Remedy
Is it time to replace the lamp?	When the lamp is nearly ready for replacement, the images become darker and the color quality becomes poorer. When this happens, replace the lamp with a new lamp. <a href="#">p.120</a>

### Projection stops automatically

Check	Remedy
Is <b>Sleep Mode</b> enabled?	If the set time is exceeded and no signal is input, the lamp is automatically turned off and the projector enters standby mode. The projector returns from standby status when you press the  button on the remote control or the  button on the control panel. If you want to disable <b>Sleep Mode</b> , change the setting to <b>Off</b> . <b>Extended - Operation - Sleep Mode</b> <a href="#">p.92</a>

### Slideshow does not start

Check	Remedy
Is the USB storage device using a security function?	You may not be able to use USB storage devices that incorporate security functions.







## Noise problems

### No audio, or the audio is too low

Check	Remedy
Is the audio cable connected correctly?	Try disconnecting the cable from the Audio Out port, and then reconnecting.
Is the volume too low?	Adjust the volume so that you can hear the audio. <a href="#">p.35</a>
Is it connected with an HDMI cable?	If no audio is output when connecting via an HDMI cable, set the connected equipment to PCM output.
Are the <b>Audio Out Device</b> settings correct?	Check that the <b>Audio Out Device</b> settings are correct on the Configuration menu. <b>Settings - HDMI Link - Audio Out Device</b> <a href="#">p.89</a>
Are the <b>Bluetooth Audio</b> settings correct?	Make the following settings when connecting a Bluetooth audio device. <ul style="list-style-type: none"> <li>To output audio from the projector's speaker or an AV system, set <b>Bluetooth Audio</b> to <b>Off</b>.</li> <li>To output audio from Bluetooth audio devices, set <b>Bluetooth Audio</b> to <b>On</b>.</li> </ul> <b>Settings - Bluetooth - Bluetooth Audio</b> <a href="#">p.89</a>





■ Problems when projection starts

The projector does not turn on

Check	Remedy
Is the power turned on?	Press the  button on the remote control or the  button on the control panel.
Is <b>Child Lock</b> set to <b>On</b> ?	When <b>Child Lock</b> is set to <b>On</b> from the Configuration menu, hold down the  button on the control panel for approximately three seconds, or perform operations from the remote control.  <b>Settings - Lock Setting - Child Lock</b> p.89
Do the indicators turn on and off when the power cord is touched?	Turn off the projector, and then disconnect and reconnect the projector's power cord. If the problem continues, stop using the projector, remove the power plug from the electrical outlet, and contact your local dealer or the nearest projector information center.  <a href="#">Epson Projector Contact List</a>
Are the lamp cover and lamps installed correctly?	If the lamp or lamp cover is installed incorrectly, the projector cannot be turned on. Check how it is installed.  p.120



■ Problems with the remote control

The remote control does not respond

Check	Remedy
Is the remote control light-emitting area pointing towards the remote receiver on the projector during operation?	Point the remote control towards the remote receiver. Also, check the operating range.  p.27
Is the remote control too far from the projector?	Check the operating range.  p.27
Is direct sunlight or strong light from fluorescent lamps shining onto the remote receiver?	Set the projector up in a location where strong light does not shine onto the remote receiver.
Are the batteries dead or have the batteries been inserted correctly?	Make sure the batteries are inserted correctly or replace the batteries with new ones if necessary.  p.27
Is the remote control pointed at the WirelessHD Transmitter when operating the WirelessHD Transmitter control button? (EH-TW6700W only)	Make sure you point the remote control at the WirelessHD Transmitter when using the WirelessHD Transmitter control button on the remote control.  p.67

■ Problems with the control panel

Cannot make settings on the control panel

Check	Remedy
Is <b>Control Panel Lock</b> set to <b>Full Lock</b> or <b>Partial Lock</b> ?	When <b>Control Panel Lock</b> is set to <b>Full Lock</b> in the Configuration menu, all button operations on the control panel are disabled; when <b>Partial Lock</b> is set, only the  button on the control panel is available. Perform operations from the remote control.  <b>Settings - Lock Setting - Control Panel Lock</b> p.89

■ Problems with 3D

Cannot project correctly in 3D

Check	Remedy
Are the 3D Glasses turned on?	Turn on the 3D Glasses.
Is a 3D image being projected?	If the projector is projecting a 2D image, or if an error occurs on the projector that prevents the 3D image from being projected, you cannot view 3D images even if you are wearing the 3D Glasses.
Is the input image in 3D?	Check that the input image is 3D compatible. Since most TV broadcasts do not contain a 3D format signal, 3D reception must be set manually.
Is <b>3D Display</b> set to <b>2D</b> ?	If <b>3D Display</b> is set to <b>2D</b> from the Configuration menu, the projector does not automatically change to 3D even when a 3D image is input. Set <b>3D Display</b> to <b>3D</b> or <b>Auto</b> . 🖱️ <b>Signal - 3D Setup - 3D Display p.88</b>
Is <b>3D Format</b> set correctly?	Unless the 3D format of the AV device and <b>3D Format</b> of the projector are the same, part of the image may not be displayed. Check that the projector's <b>3D Format</b> setting matches the 3D format setting for the AV device. 🖱️ <b>Signal - 3D Setup - 3D Format p.88</b>  When changing the <b>3D Format</b> , set <b>3D Display</b> to <b>3D</b> , and then press the  button.
Are you viewing within the reception range?	If the distance between the projector and the 3D Glasses exceed 10 m, the connection may be lost. Move the 3D Glasses closer to the projector.
Has pairing been performed correctly?	Perform pairing. 🖱️ <b>p.51</b>
Are there any devices that cause radio wave interference in the vicinity?	When using other devices at the same time with the frequency band (2.4 GHz) such as Bluetooth communication devices, wireless LAN (IEEE802.11b/g), or microwave ovens, radio wave interference may occur, the image may be interrupted, or communication may not be possible. Do not use the projector near these devices.

■ Problems with HDMI

HDMI Link does not function

Check	Remedy
Are you using a cable that meets the HDMI standards?	Operations are not possible with cables that do not meet the HDMI standards.
Does the connected device meet the HDMI CEC standards?	If the connected device does not meet the HDMI CEC standards, it cannot be operated even if it is connected to the HDMI port. See the documentation and so on supplied with the connected device for more information. Also, press the  button, and then check if the device is available under <b>Device Connections</b> . 🖱️ <b>p.71</b>

Check	Remedy
Are the cables connected correctly?	Check that all the cables required to use HDMI Link are securely connected.  <a href="#">p.70</a>
Is the power for the amplifier or DVD recorder and so on turned on?	Put each device in standby status. See the documentation and so on supplied with the connected device for more information. If you have connected a speaker and so on, set the connected equipment to PCM output.
Was a new device connected, or was the connection changed?	If the CEC function for a connected device needs to be set again, for example when a new device is connected or the connection is changed, you may need to restart the device.
Are many multi-media players connected?	Up to 3 multi-media players that meet the HDMI CEC standards can be connected at the same time.

### The device name is not displayed under Device Connections

Check	Remedy
Does the connected device meet the HDMI CEC standards?	If the connected device does not meet the HDMI CEC standards, it is not displayed. See the documentation and so on supplied with the connected device for more information.

## Bluetooth device problems

### Cannot Connect Bluetooth Device



Check	Remedy
Was a device search performed?	When connecting a Bluetooth device for the first time, or when changing to another Bluetooth device, perform <b>Search Bluetooth Device</b> .  <a href="#">p.22</a>
Does the device support copyright protection (SCMS-T)?	You cannot connect a Bluetooth device that does not support copyright protection (SCMS-T).
Is the device based on A2DP?	You cannot connect a Bluetooth device that does not support A2DP.

### The audio and connection for the Bluetooth device disconnects



Check	Remedy
Are there any obstacles between the projector and the Bluetooth device?	Check for any obstacles between the projector and the Bluetooth device, and change their positions to improve communication.
Is the device connected within the specified communication distance?	If the distance between the projector and the Bluetooth device exceed 10 m, the connection may be lost. Move the Bluetooth device closer to the projector.
Are there any wireless equipment or microwave ovens in the vicinity?	If the device is used at the same time as other wireless equipment or microwave ovens, radio wave interference may occur, and the image and audio may be interrupted. Avoid equipment that could cause interference.



■ Problems with WirelessHD (EH-TW6700W only)

Cannot project WirelessHD images

Check	Remedy
Does the cable connecting the supplied WirelessHD Transmitter meet the HDMI standards?	If the cable does not meet the HDMI standards, operations are not possible.
Is <b>WirelessHD</b> set to <b>Off</b> ?	When <b>WirelessHD</b> is set to <b>Off</b> from the Configuration menu, projection is not possible for WirelessHD input signals. Set <b>WirelessHD</b> to <b>On</b> , and then press the  button.  <b>Settings - WirelessHD - WirelessHD</b> p.89
Are signals being received within the WirelessHD transmission range?	Check the range within which the WirelessHD's transceiver can communicate, and view within that range.  p.66
Is the supplied WirelessHD Transmitter turned on?	Check the power lamp on the WirelessHD Transmitter. If there is no power being supplied, make sure the connector for the AC adapter is securely connected, and then turn on the power switch.
Is the WirelessHD indicator for the supplied WirelessHD Transmitter off?	The WirelessHD cannot communicate with the projector. Check the range within which the WirelessHD's transceiver can communicate, and setup within that range.
Is the Link indicator for the supplied WirelessHD Transmitter off?	No signal is output from the AV device connected to the WirelessHD Transmitter. Check that the cables from the AV device and the WirelessHD Transmitter are securely connected.
Has dust collected in the WirelessHD Transmitter's vent?	There is an air exhaust vent on the bottom of the WirelessHD Transmitter. Communication may not be possible if dust has collected in the vent. Install the projector so that dust does not collect in the vent.
Are the projector and the WirelessHD Transmitter facing the correct way?	Setup the projector and the WirelessHD Transmitter so that they are facing each other.

Interference, distortion, or interruption appear in WirelessHD

Check	Remedy
Are signals being received within the WirelessHD transmission range?	Check the range within which the WirelessHD's transceiver can communicate, and view within that range.  p.66
Are there any obstructions between the WirelessHD Transmitter and the projector?	Because WirelessHD communicates using a tight beamed electromagnetic wave, if there are any people or objects and so on obstructing the communication path, this could have an adverse affect on the image. Make sure that there are no obstacles between the WirelessHD Transmitter and the projector within the WirelessHD transmission range.  p.66





Check	Remedy
Is the reception too low?	<p>If the transmissions are not strong enough, communication may be unstable.</p> <p>Check <b>Video Reception</b> as you set up the transmitter as it is sometimes possible to improve the strength of the transmission by moving the WirelessHD Transmitter or changing its direction.  <b>Settings - WirelessHD - Video Reception</b> <a href="#">p.89</a></p> <p>Transmission strength may differ depending on the surroundings, or they may be unstable. While checking <b>Video Reception</b>, setup the transmitter in a location where the value displayed remains steady.  <b>Settings - WirelessHD - Video Reception</b> <a href="#">p.89</a></p>

Half of the image on the left or right stops projecting or the image is doubled up

Check	Remedy
Is the reception too low?	<p>Check <b>Video Reception</b> as you set up the transmitter as it is sometimes possible to improve the strength of the transmission by moving the WirelessHD Transmitter or changing its direction.  <b>Settings - WirelessHD - Video Reception</b> <a href="#">p.89</a></p>

 Network problems

Cannot access the network via wireless LAN

Check	Remedy
Is <b>Wireless LAN Power</b> set to <b>Off</b> ?	Set <b>Wireless LAN Power</b> to <b>On</b> in the Configuration menu. If this is already set to <b>On</b> , set <b>Wireless LAN Power</b> to <b>Off</b> , and then set it to <b>On</b> again.  <b>Network - Wireless LAN Power</b> <a href="#">p.95</a>
Is the passphrase correct?	Note that the passphrase is case sensitive; upper case and lower case letters are treated as different characters. If you have forgotten your passphrase, set a new one.  <b>Network - Network Configuration - Security - Passphrase</b> <a href="#">p.98</a>
Have you checked the Event ID?	Check the Event ID number and perform the following steps.  <b>Info - Projector Info - Event ID</b> <a href="#">p.99</a>  <a href="#">p.114</a>

The image contains static during network projection

Check	Remedy
Are there any obstacles between the access point and the connected device?	Check for any obstacles between the access point, the mobile device, the computer, and the projector, and change their positions to improve communication.
Is the distance between the access point and the connected device too far?	Make sure that the access point, the mobile device, the computer, and the projector are not too far apart. Move them closer together and try to connect again.

Check	Remedy
Are there any Bluetooth devices or microwave oven in the vicinity?	If the wireless connection is slow or your projected image contains noise, check for interference from other equipment, such as a Bluetooth device or microwave. Move the interfering device farther away or expand your wireless bandwidth.
Are too many devices connected?	Reduce the number of connected devices if the connection speed declines.

## About Event ID

Check the event ID and perform the remedy given below. If you cannot resolve the problem, contact your local dealer or the nearest Epson repair center.

 [Epson Projector Contact List](#)

Event ID	Cause	Remedy
0022 0027 0028 0029 0030 0031 0035 0434 0481 0482 0485	Network communication is unstable.	Check the network communication status, and reconnect after waiting for a while.
0432 0435	Failed to start the network software.	Restart the projector.
0433	An image that was transferred cannot be reproduced.	Restart the network software.
0484	Communications was cut off from the computer.	
04FE	The network software ended unexpectedly.	Check the status of network communications. Wait for a while and then try connecting again.
0479 04FF	A system error occurred in the projector.	Restart the projector.
0891	The same SSID access point cannot be found.	Set the computer, the access point, and the projector to the same SSID.
0892	WPA and WPA2 authentication type mismatch.	Check the setting of wireless LAN security to see if it is correct.
0894	Communications was cut off because a connection was made to the wrong access point.	Check with the network administrator and follow their instructions.
0898	Failed to acquire the DHCP.	Check the DHCP server to see if it is operating correctly. Turn off DHCP if it is not being used.  <b>Network - Network Configuration - Wireless LAN - IP Settings - DHCP</b> <a href="#">p.95</a>

Event ID	Cause	Remedy
0020 0026 0032 0036 0037 0038 0899	Other connection errors	If restarting the projector or network software does not solve the problem, contact your local dealer or the nearest address provided in the Epson Projector Contact List. <a href="#">Epson Projector Contact List</a>





# Maintenance

## Cleaning the Parts

You should clean the projector if it becomes dirty or if the quality of projected images starts to deteriorate.

### Warning

Do not use sprays that contain flammable gas to remove dirt and dust from the projector's lens, air filter, and so on. The projector may catch fire due to the high internal temperature of the lamp.

### Cleaning the air filter

Clean the air filter if dust has accumulated on the air filter or when the following message is displayed. **"The projector is overheating. Make sure nothing is blocking the air vent, and clean or replace the air filter."**

### Attention

- If dust collects on the air filter, it can cause the internal temperature of the projector to rise, and this can lead to problems with operation and shorten the optical engine's service life. It is recommended that you clean the air filter at least once every three months. Clean them more often than this if using the projector in a particularly dusty environment.
- Do not rinse the air filter in water. Do not use detergents or solvents.
- Lightly brush the air filter to clean it. If it is brushed too strongly, dust will be ground into the air filter and cannot be removed.

**1** Press the  button on the remote control or the control panel to turn off the power, and then disconnect the power cord.

**2** Remove the air filter cover. Hook your finger into the tab on the air filter cover, and remove it downward.

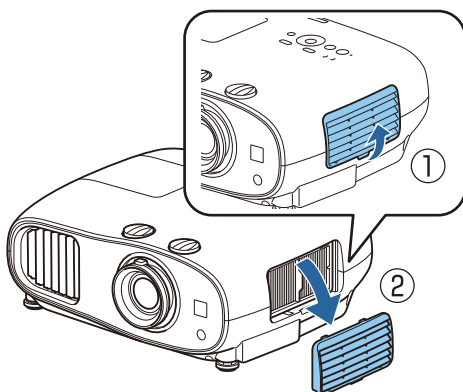

**3** Remove the air filter. Grip the knob in the center of the air filter and pull it out.

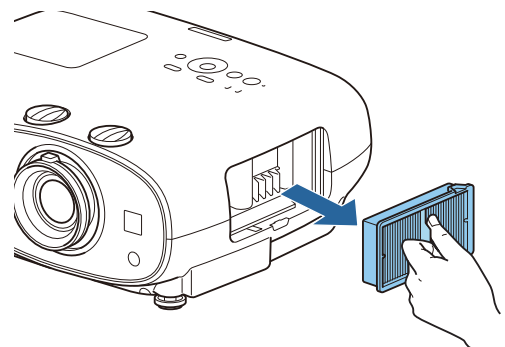

- 4** Hold the air filter with the surface facing down and tap it 4 or 5 times to remove the dust.

Turn it over and tap the other side in the same way.

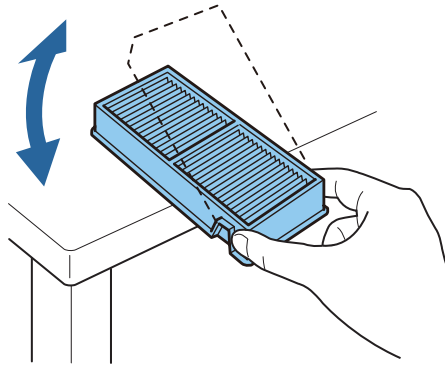

**Attention**

If the air filter is hit too hard, it may become unusable due to deformities and cracks.

- 5** Remove any dust remaining on the air filter by using a vacuum cleaner from the front side.

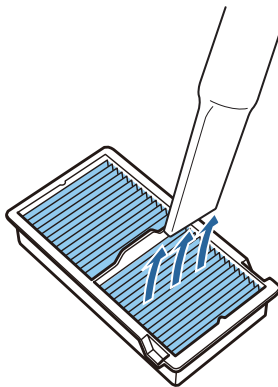

- 6** Install the air filter. Grip the air filter by the knob in the center and insert it straight.

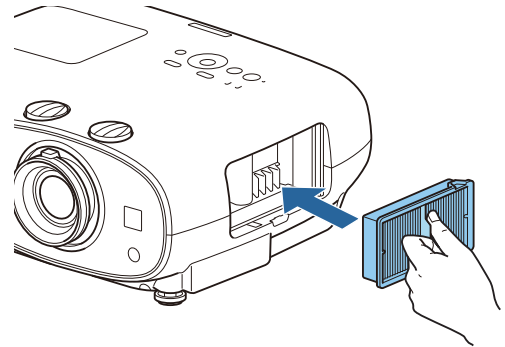

- 7** Install the air filter cover. Fasten the upper catch and then the lower one.

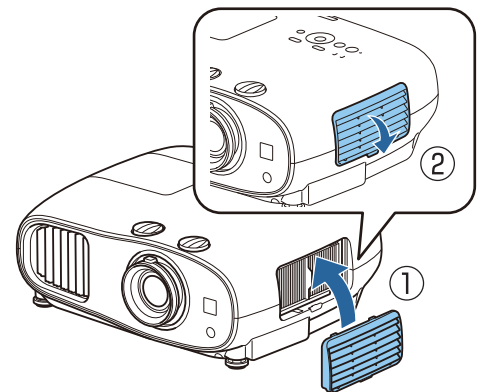

**■** Cleaning the main unit

Before cleaning, make sure you unplug the charging adapter from the outlet.

Clean the projector's surface by wiping it gently with a soft cloth.

If it is particularly dirty, moisten the cloth with water containing a small amount of neutral detergent, and then firmly wring the cloth dry before using it to wipe the surface.

**Attention**

Do not use volatile substances such as wax, alcohol, or thinner to clean the projector's surface. The quality of the case may change or the paint may peel off.

## ■ Cleaning the lens

Before cleaning, make sure you unplug the charging adapter from the outlet.

Use a commercially available cloth for cleaning glasses to gently wipe off dirt from the lens.

### Attention

Do not rub the lens with harsh materials or handle the lens too roughly as it can easily become damaged.

## ■ Cleaning the 3D Glasses

Use a commercially available cloth for cleaning glasses to gently wipe off dirt from the lens.

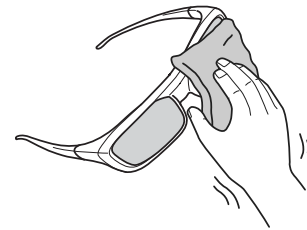

### Attention

- Do not rub the lenses of the glasses with harsh materials or handle the lenses too roughly as they can easily become damaged.
- When maintenance is necessary, disconnect the USB Charging Adapter from the electrical outlet, and check that all cables have been disconnected.



The 3D Glasses contain rechargeable batteries. Observe local regulations when you dispose of them.

## Replacement Periods for Consumables

### ■ Air filter replacement period

- If the message is displayed even though the air filter has been cleaned  [p.116](#)

### ■ Lamp replacement period

- The following message is displayed when projection starts:  
It is time to replace your lamp. Please contact your Epson projector reseller or visit [www.epson.com](http://www.epson.com) to purchase.
- The projected image gets darker or starts to deteriorate.



- The lamp replacement message is set to appear after 3400 H in order to maintain the initial brightness and quality of the projected images. The message display time changes depending on the usage situation, such as the color mode setting and so on.  
If you continue to use the lamp after the replacement period has passed, the possibility that the lamp may explode increases. When the lamp replacement message appears, replace the lamp with a new one as soon as possible, even if it is still working.
- Depending on the characteristics of the lamp and the way it has been used, the lamp may become darker or stop working before the lamp warning message appears. You should always have a spare lamp unit ready in case it is needed.

## Replacing Consumables

### Replacing the air filter



Dispose of used air filters properly in accordance with your local regulations.

Material: Polypropylene

- 1 Press the  button on the remote control or the control panel to turn off the power, and then disconnect the power cord.

- 2 Remove the air filter cover.  
Hook your finger into the tab on the air filter cover, and remove it downward.

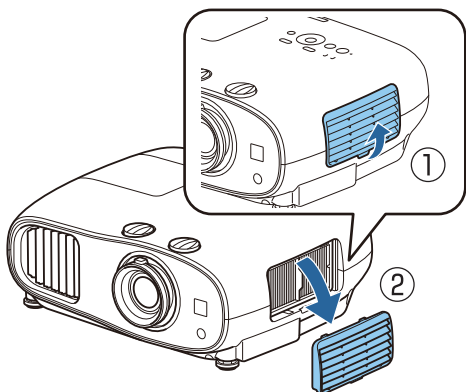

- 3 Remove the old air filter.  
Grip the knob in the center of the air filter and pull it out.

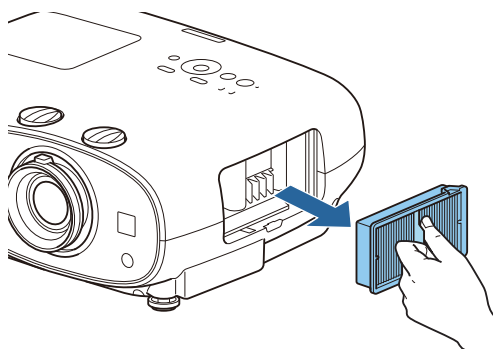

- 4 Install the new air filter.  
Grip the air filter by the knob in the center and insert it straight.

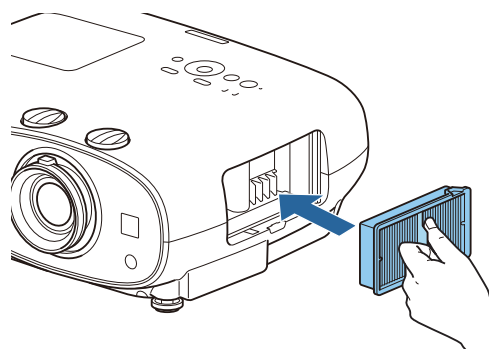

- 5 Install the air filter cover.  
Fasten the upper catch and then the lower one.

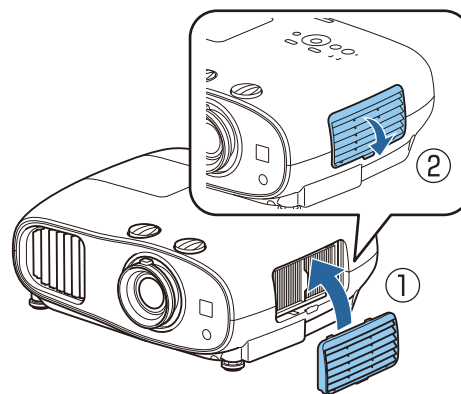

## ■ Replacing the lamp

### ⚠ Warning

When replacing the lamp because it has stopped illuminating, there is a possibility that the lamp may be broken. If replacing the lamp of a projector that has been suspended from the ceiling, you should always assume that the lamp is cracked, and remove the lamp cover with care. When you open the lamp cover, small shards of glass could fall out. If any shards of glass get into your eyes or mouth, contact a doctor immediately.

### ⚠ Caution

- Do not touch the lamp cover immediately after turning off the projector as it is still hot. Wait until the lamp has cooled down sufficiently before removing the lamp cover. Otherwise, you could get burnt.
- We recommend the use of genuine EPSON option lamps. The use of non-genuine lamps may affect projection quality and safety.  
Any damage or malfunction caused by the use of non-genuine lamps may not be covered by Epson's warranty.

- 1 Press the  button on the remote control or the control panel to turn off the power, and then disconnect the power cord.

- 2 Loosen the lamp cover fixing screw.

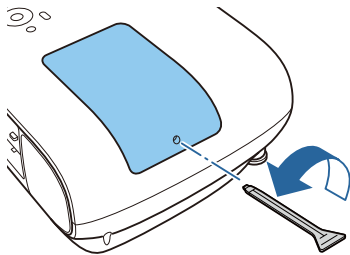

- 3 Remove the lamp cover.  
Slide the lamp cover straight forward and remove it.

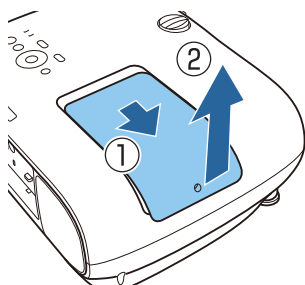

- 4 Loosen the two lamp fixing screws.

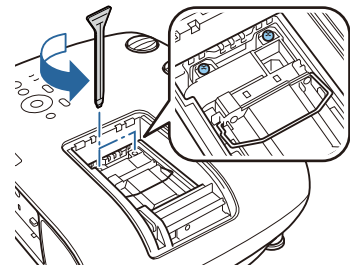

- 5 Remove the old lamp.  
Grip the knob firmly and pull it straight out.

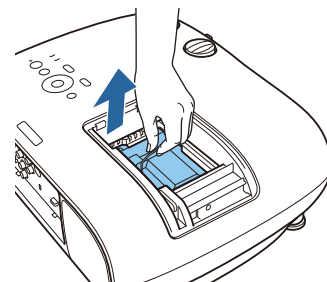

- 6** Install the new lamp.  
Make sure the lamp is facing the correct direction and press it in.

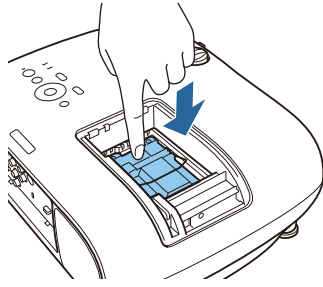

- 7** Tighten the two lamp fixing screws.

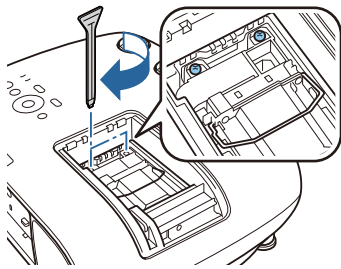

- 8** Replace the lamp cover.  
Slide the cover back into place.

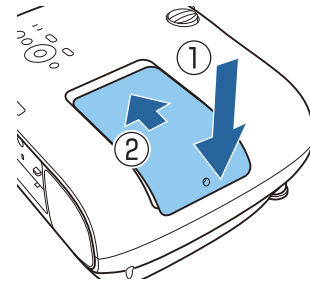

- 9** Tighten the lamp cover fixing screw.

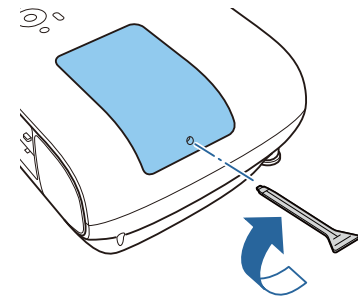

**Warning**

Do not disassemble or remodel the lamp. If a modified or disassembled lamp is installed in the projector and used, it could cause a fire, electric shock, or an accident.

**Caution**

- Make sure you install the lamp and lamp cover securely. If they are not installed correctly, the power does not turn on.
- The lamp contains mercury (Hg). Dispose of used lamps in accordance with your local laws and regulations on disposing of fluorescent tubing.

**Resetting lamp hours**

After replacing the lamp, make sure you reset the lamp hours.

The projector records how long the lamp is turned on and a message and indicator notify you when it is time to replace the lamp.

- 1** Turn on the power.

- 2** Press the **Menu** button.  
The Configuration menu is displayed.



3

Select **Reset - Reset Lamp Hours**.

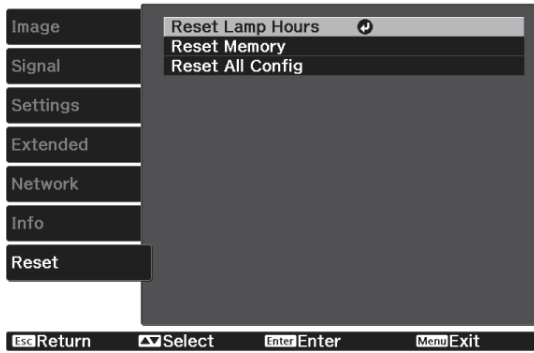
A reset confirmation message is displayed.



4

Use the   buttons to select **Yes**, and then press the  button to execute.

The lamp hours are reset.

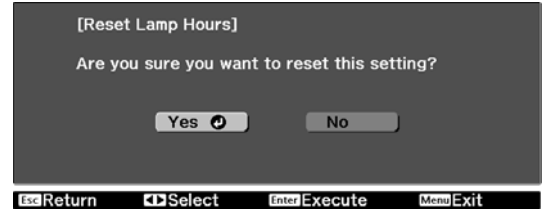

# Panel Alignment

Adjusts the pixel color shift of the LCD display. You can adjust the pixels horizontally and vertically by 0.125 pixel within a range of  $\pm 3$  pixel.



- Image quality may decline after performing LCD alignment.
- Images for pixels that extend beyond the edge of the projected screen are not displayed.

**1** Press the **Menu** button while projecting, and then select **Display** from **Extended**.

**2** Select **Panel Alignment**, and then press the **Enter** button.

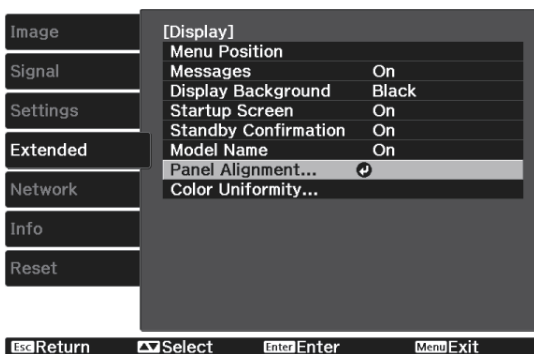

**3** Enable **Panel Alignment**.

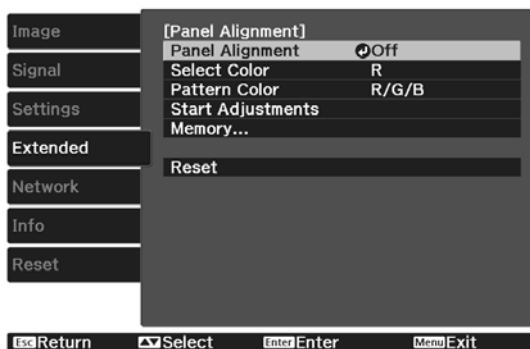

- (1) Select **Panel Alignment**, and then press the **Enter** button.
- (2) Select **On**, and then press the **Enter** button.
- (3) Press the **Esc** button to return to the previous screen.

**4** Select the color you want to adjust.

- (1) Select **Select Color**, and then press the **Enter** button.
- (2) Select **R** (red) or **B** (blue), and then press the **Enter** button.
- (3) Press the **Esc** button to return to the previous screen.

**5** Select the grid color displayed when making adjustments from **Pattern Color**.

- (1) Select **Pattern Color**, and then press the **Enter** button.
- (2) Select a combination of R (red), G (green), and B (blue) for the grid color.



**R/G/B:** Displays a combination all three colors; red, green and blue. The actual color of the grid is white.

**R/G:** This is available when **R** is selected from **Select Color**. Displays a combination of two colors; red and green. The actual color of the grid is yellow.

**G/B:** This is available when **B** is selected from **Select Color**. Displays a combination of two colors; green and blue. The actual color of the grid is cyan.





- (3) Press the **Esc** button to return to the previous screen.



**6** Select **Start Adjustments**, and then press the  button. When the message is displayed, press the  button again.

Adjustments start. Adjustments are performed in four corners starting from the top-left corner.

 The image may become distorted while adjusting. The image is restored once adjustments are complete.

**7** Use the , , , and  buttons to make adjustments, and then press the  button to move to the next adjustment point.

**8** When you have adjusted all four corners, select **Exit**, and then press the  button.

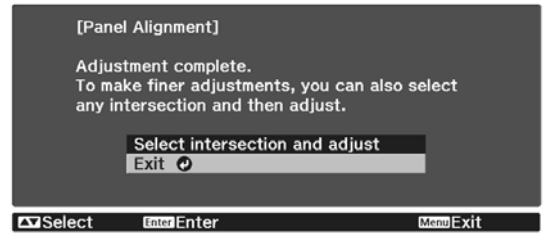

If you feel you still need to make adjustments after correcting all four points, select **Select intersection and adjust** and then continue making adjustments.

# Color Uniformity (EH-TW6800 Only)

If colors in the projected image are uneven, you can adjust the color tone of the whole image in **Color Uniformity**.



The color tone may not be uniform even after performing color uniformity.

1 Press the **Menu** button while projecting, and then select **Display** from **Extended**.

2 Select **Color Uniformity**, and then press the **Enter** button.

The following screen is displayed.

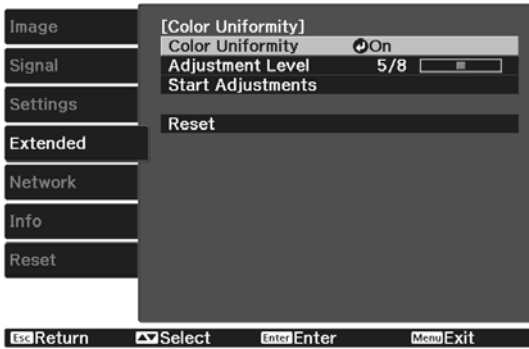

**Color Uniformity:** Turns color uniformity on or off.

**Adjustment Level:** There are eight levels from white, through gray, and up to black. You can adjust each level individually.

**Start Adjustments:** Starts making color uniformity adjustments.

**Reset:** Resets all adjustments and settings for **Color Uniformity** to their default values.



The image may become distorted while adjusting **Color Uniformity**. The image is restored once adjustments are complete.

3 Select **Color Uniformity**, and then press the **Enter** button.

4 Set this to **On**, and then press the **Esc** button.

5 Select **Adjustment Level**, and then press the **Enter** button.

6 Use the **Left** and **Right** buttons to set the adjustment level.

7 Press the **Esc** button to return to the previous screen.





8 Select **Start Adjustments**, and then press the **Enter** button.

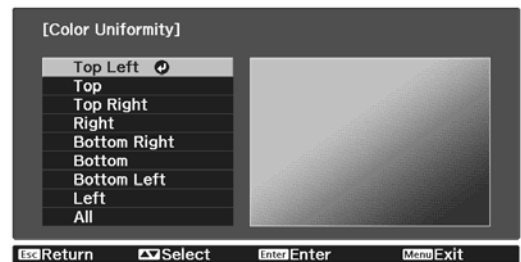

9 Select the area you want to adjust, and then press the **Enter** button.

Adjust the outer areas first, and then adjust the whole screen.



10

Use the   buttons to select the color you want to adjust, and then use the   buttons to adjust.

Press the  button to weaken the color tone. Press the  button to strengthen the color tone.



11

Return to step 5 and adjust each level.

12

To complete the adjustment, press the  button.



## About PLink (EH-TW6800 Only)

PLink Class1 was established by the JBMIA (Japan Business Machine and Information System Industries Association) as a standard protocol for controlling network-compatible projector's as part of their efforts to standardize projector control protocols.

The projector complies with the PLink Class1 standard established by the JBMIA.

You need to make network settings before you can use PLink. See the following for more information on network settings.

 [p.95](#)

It complies with all commands except for the following commands defined by PLink Class1, and agreement was confirmed by the PLink standard adaptability verification.

URL: <http://plink.jbmia.or.jp/english/>

- **Non-compatible commands**

Function		PLink Command
Mute settings	Image muting set	AVMT 11
	Audio muting set	AVMT 21

- **Input names defined by PLink and corresponding projector sources**

Source	PLink Command
PC	INPT 11
HDMI1	INPT 32
HDMI2	INPT 33
USB	INPT 41
LAN	INPT 52

- Manufacturer name displayed for "Manufacture name information query"

**EPSON**

- Model name displayed for "Product name information query"

EPSON TW6800



## Optional Accessories and Consumables

The following optional accessories/consumables are available for purchase if required. This list of optional accessories/consumables is current as of: June 2016. Details of accessories are subject to change without notice.

Varies depending on country of purchase.

### Optional Items

Name	Model No.	Explanation
Ceiling mount*	ELPMB20 ELPMB22 ELPMB30	Use when installing the projector on a ceiling.
Ceiling pipe 450 (450 mm white)*	ELPFP13	Use when installing the projector on a high ceiling.
Ceiling pipe 700 (700 mm white)*	ELPFP14	
RF system 3D Glasses	ELPGS03	Use when viewing 3D images.
USB Charging Adapter	ELPAC01	Use when charging the 3D Glasses.
Computer cable (1.8 m)	ELPKC02	Use when projecting a computer's screen.
Computer cable (3.0 m)	ELPKC09	
Computer cable (20.0 m)	ELPKC10	
Wireless LAN unit	ELPAP10	Use when connecting an external device to the projector via a wireless LAN to project images.

\* Special expertise is required to suspend the projector from a ceiling. Contact your local dealer.

### Consumables

Name	Model No.	Explanation
Lamp unit	ELPLP85	Use as a replacement for used lamps. (1 lamp)
Air filter	ELPAF39	Use as a replacement for used air filters. (1 air filter)



## Supported Resolutions

### Computer Signals (Analog RGB)

Signal	Refresh Rate (Hz)	Resolution (dots)
VGA	60	640 x 480
SVGA	60	800 x 600
XGA	60	1024 x 768
SXGA	60	1280 x 960
	60	1280 x 1024
WXGA	60	1280 x 768
	60	1366 x 768
	60	1280 x 800
WXGA++	60	1600 x 900

### HDMI1/HDMI2 Input Signal

Signal	Refresh Rate (Hz)	Resolution (dots)
VGA	60	640 x 480
SDTV (480i)	60	720 x 480
SDTV (576i)	50	720 x 576
SDTV (480p)	60	720 x 480
SDTV (576p)	50	720 x 576
HDTV (720p)	50/60	1280 x 720
HDTV (1080i)	50/60	1920 x 1080
HDTV (1080p)	24/30/50/60	1920 x 1080

### MHL Input Signal

Signal	Refresh Rate (Hz)	Resolution (dots)
VGA	60	640 x 480
SDTV (480i)	50	720 x 480
SDTV (576i)	60	720 x 576
SDTV (480p)	50	720 x 480
SDTV (576p)	60	720 x 576
HDTV (720p)	50/60	1280 x 720
HDTV (1080i)	50/60	1920 x 1080
HDTV (1080p)	24/30	1920 x 1080

## 3D Input Signal HDMI

Signal	Refresh Rate (Hz)	Resolution (dots)	3D Format		
			Frame Packing	Side by Side	Top and Bottom
HDTV (720p)	50/60	1280 x 720	✓	✓	✓
HDTV (1080i)	50/60	1920 x 1080	-	✓	-
HDTV (1080p)	50/60	1920 x 1080	-	✓	-
HDTV (1080p)	24	1920 x 1080	✓	✓	✓

## 3D Input Signal MHL

Signal	Refresh Rate (Hz)	Resolution (dots)	3D Format		
			Frame Packing	Side by Side	Top and Bottom
HDTV (720p)	50/60	1280 x 720	-	✓	✓
HDTV (1080i)	50/60	1920 x 1080	-	✓	-
HDTV (1080p)	50/60	1920 x 1080	-	-	-
HDTV (1080p)	24	1920 x 1080	-	✓	✓

## WirelessHD Input Signal

Signal	Refresh Rate (Hz)	Resolution (dots)
SDTV (480i)	60	720 x 480
SDTV (576i)	50	720 x 576
SDTV (480p)	60	720 x 480
SDTV (576p)	50	720 x 576
HDTV (720p)	50/60	1280 x 720
HDTV (1080i)	50/60	1920 x 1080
HDTV (1080p)	24/30	1920 x 1080

\* When projecting in WirelessHD, the following signals do not support Deep Color.

2D: 1080p 60/50 Hz

3D: 1080p 24 Hz frame packing/720p 50/60 Hz frame packing/1080p 60/50 Hz side by side

## WirelessHD\* Input Signal MHL

Signal	Refresh Rate (Hz)	Resolution (dots)
SDTV (480i)	60	720 x 480
SDTV (576i)	50	720 x 576
SDTV (480p)	60	720 x 480

Signal	Refresh Rate (Hz)	Resolution (dots)
SDTV (576p)	50	720 x 576
HDTV (720p)	50/60	1280 x 720
HDTV (1080i)	50/60	1920 x 1080
HDTV (1080p)	24/30/50/60	1920 x 1080

\* HDMI4 port only.





# Specifications

## EH-TW6800/EH-TW6300

Product name		EH-TW6800	EH-TW6300
Appearance		410 (W) x 157 (H) x 310 (D) mm (not including adjustable foot)	410 (W) x 157 (H) x 304 (D) mm (not including adjustable foot)
Panel Size		0.61" wide	
Display method		Polysilicon TFT active matrix	
Resolution		1920 (W) x 1080 (H) x 3	
Focus adjustment		Manual	
Zoom adjustment		Manual (Approx. 1 to 1.6)	
Lamp (light source)		UHE lamp 250 W, Model No.: ELPLP85	
Lamp replacement time		3400 hours	
Power supply		100 - 240 V AC $\pm$ 10%, 50/60 Hz, 3.6 - 1.6 A	
Power consumption	100 to 120 V area	Rated power consumption: 331 W	
		Standby power consumption (Communication On): 2.8 W	
		Standby power consumption (Communication Off): 0.30 W	
	220 to 240 V area	Rated power consumption: 317 W	
		Standby power consumption (Communication On): 2.9 W	
		Standby power consumption (Communication Off): 0.40 W	
Operating altitude		Altitude 0 to 3,000 m	
Operating temperature		+5 to +35°C * (No condensation)	
Storage temperature		-10 to +60°C (No condensation)	
Mass		Approx. 6.6 kg	
Speaker		-	

\* The operating temperature is +5 to +30°C at an altitude of 2287 to 3000m.

Product name			EH-TW6800	EH-TW6300
Connectors	PC port	1	Mini D-sub15-pin (female) blue	
	HDMI port	2	For HDMI HDCP, For CEC signals, For MHL signals (HDMI2 port only), For 3D signals, Deep Color	For HDMI HDCP, For CEC signals, For MHL signals (HDMI2 port only), For 3D signals, For linear PCM, Deep Color
	USB port*	1	USB connector (Type A)	
	1000 mA power supply port*	1	USB connector (Type A)	-
	Audio Out port	1	-	Stereo mini jack (3.5Φ)
	RS-232C port	1	D-sub 9-pin (male)	-
	Trigger Out port	1	Stereo mini jack (3.5Φ)	-
	LAN port	1	RJ-45	-
	Service port*	1	USB connector (Type B)	

\* Supports USB 2.0. However, USB ports are not guaranteed to operate all devices that support USB.

### EH-TW6700W/EH-TW6700

Product name		EH-TW6700W	EH-TW6700
Appearance		410 (W) x 157 (H) x 304 (D) mm (not including adjustable foot)	
Panel Size		0.61" wide	
Display method		Polysilicon TFT active matrix	
Resolution		1920 (W) x 1080 (H) x 3	
Focus adjustment		Manual	
Zoom adjustment		Manual (Approx. 1 to 1.6)	
Lamp (light source)		UHE lamp 250 W, Model No.: ELPLP85	
Lamp replacement time		3400 hours	
Power supply		100 - 240 V AC ±10%, 50/60 Hz, 3.9 - 1.7 A	
Power consumption	100 to 120 V area	Rated power consumption: 357 W	
		Standby power consumption (Communication On): 2.8 W	
		Standby power consumption (Communication Off): 0.30 W	
	220 to 240 V area	Rated power consumption: 340 W	
		Standby power consumption (Communication On): 2.9 W	
		Standby power consumption (Communication Off): 0.40 W	
Operating altitude		Altitude 0 to 3,000 m	
Operating temperature		+5 to +35°C * (No condensation)	
Storage temperature		-10 to +60°C (No condensation)	
Mass		Approx. 7.0 kg	Approx. 6.9 kg
Speaker		10 W x 2	

\* The operating temperature is +5 to +30°C at an altitude of 2287 to 3000m.

Connectors	PC port	1	Mini D-sub15-pin (female) blue
	HDMI port	2	For HDMI HDCP, For CEC signals, For MHL signals (HDMI2 port only), For 3D signals, For linear PCM, Deep Color
	USB port*	1	USB connector (Type A)
	1000 mA power supply port*	1	USB connector (Type A)
	Audio Out port	1	Stereo mini jack (3.5Φ)
	Service port*	1	USB connector (Type B)

\* Supports USB 2.0. However, USB ports are not guaranteed to operate all devices that support USB.

This product is also designed for IT power distribution system with phase-to-phase voltage 230V.

### Angle of tilt

If you use the projector tilted at an angle of more than 3°, it could be damaged or cause an accident.

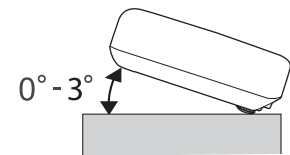

**DECLARATION of CONFORMITY**

According to 47CFR, Part 2 and 15

Class B Personal Computers and Peripherals; and/or

CPU Boards and Power Supplies used with Class B Personal Computers

We: Epson America, Inc.  
Located at: 3840 Kilroy Airport Way  
MS: 3-13  
Long Beach, CA 90806  
Tel: 562-981-3840

Declare under sole responsibility that the product identified herein, complies with 47CFR Part 2 and 15 of the FCC rules as a Class B digital device. Each product marketed, is identical to the representative unit tested and found to be compliant with the standards. Records maintained continue to reflect the equipment being produced can be expected to be within the variation accepted, due to quantity production and testing on a statistical basis as required by 47CFR 2.909. Operation is subject to the following two conditions : (1) this device may not cause harmful interference, and (2) this device must accept any interference received, including interference that may cause undesired operation.

Trade Name: EPSON  
Type of Product: LCD Projector  
Model: H798C/H799C/H800C/H829C

**FCC Compliance Statement****For United States Users**

This equipment has been tested and found to comply with the limits for a Class B digital device, pursuant to Part 15 of the FCC Rules. These limits are designed to provide reasonable protection against harmful interference in a residential installation. This equipment generates, uses, and can radiate radio frequency energy and, if not installed and used in accordance with the instructions, may cause harmful interference to radio communications. However, there is no guarantee that interference will not occur in a particular installation. If this equipment does cause harmful interference to radio or television reception, which can be determined by turning the equipment off and on, the user is encouraged to try to correct the interference by one or more of the following measures.

- Reorient or relocate the receiving antenna.
- Increase the separation between the equipment and receiver.
- Connect the equipment into an outlet on a circuit different from that to which the receiver is connected.
- Consult the dealer or an experienced radio/TV technician for help.

**WARNING**

The connection of a non-shielded equipment interface cable to this equipment will invalidate the FCC Certification or Declaration of this device and may cause interference levels which exceed the limits established by the FCC for this equipment. It is the responsibility of the user to obtain and use a shielded equipment interface cable with this device. If this equipment has more than one interface connector, do not leave cables connected to unused interfaces. Changes or modifications not expressly approved by the manufacturer could void the user's authority to operate the equipment.



# Appearance

Units: mm

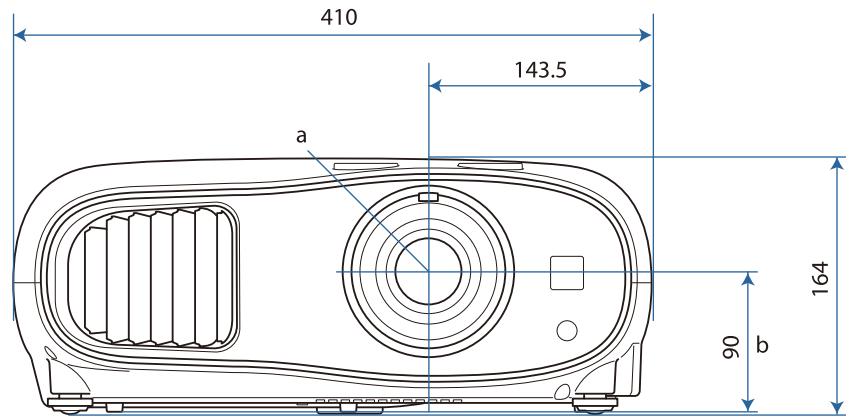



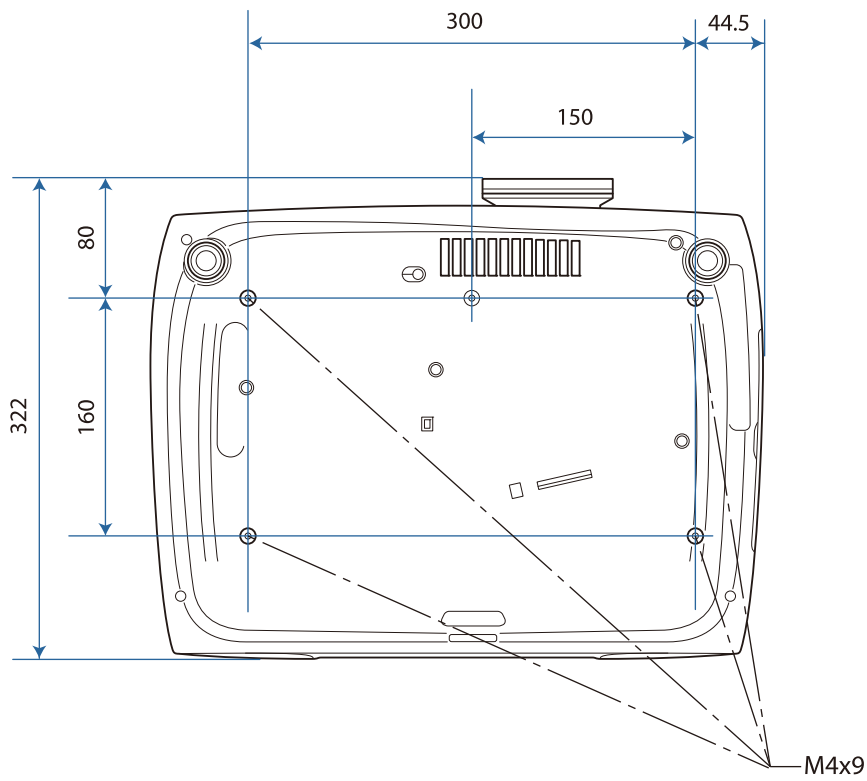























- a Center of lens
- b Distance from center of lens to suspension bracket fixing point



## List of Safety Symbols

The following table lists the meaning of the safety symbols labeled on the equipment.

Symbol mark	Approved standards	Meaning
	IEC60417 No. 5007	"ON" (power) To indicate connection to the mains.
	IEC60417 No. 5008	"OFF" (power) To indicate disconnection from the mains.
	IEC60417 No. 5009	Stand-by To identify the switch or switch position by means of which part of the equipment is switched on in order to bring it into the stand-by condition.
	ISO7000 No. 0434B IEC3864-B3.1	Caution To identify general caution when using the product.
	IEC60417 No. 5041	Caution, hot surface To indicate that the marked item can be hot and should not be touched without taking care.
	IEC60417 No. 6042 ISO3864-B3.6	Caution, risk of electric shock To identify equipment that has risk of electric shock.
	IEC60417 No. 5957	For indoor use only To identify electrical equipment designed primarily for indoor use.
	IEC60417 No. 5926	Polarity of d.c. power connector To identify the positive and negative connections (the polarity) on a piece of equipment to which a d.c. power supply may be connected.
	---	
	IEC60417 No. 5001B	Battery, general On battery powered equipment. To identify a device for instance a cover for the battery compartment, or the connector terminals.
	IEC60417 No. 5002	Positioning of cell To identify the battery holder itself and to identify the positioning of the cell(s) inside the battery holder.
	---	
	IEC60417 No. 5019	Protective earth To identify any terminal which is intended for connection to an external conductor for protection against electric shock in case of a fault, or the terminal of a protective earth electrode.
	IEC60417 No. 5017	Earth To identify an earth (ground) terminal in cases where neither the symbol  is explicitly required.

Symbol mark	Approved standards	Meaning
	IEC60417 No. 5032	Alternating current To indicate on the rating plate that the equipment is suitable for alternating current only; to identify relevant terminals.
	IEC60417 No. 5031	Direct current To indicate on the rating plate that the equipment is suitable for direct current only; to identify relevant terminals.
	IEC60417 No. 5172	Class II equipment To identify equipment meeting the safety requirements specified for Class II equipment according to IEC 61140.
	ISO 3864	General prohibition To identify actions or operations that are prohibited.
	ISO 3864	Contact prohibition To indicate injury that could occur due to touching a specific part of the equipment.
	---	Never look into the projection lens while the projector is on.
	---	To indicate that the marked item don't place anything on projector.
	ISO3864 IEC60825-1	Caution, laser radiation To indicate the equipment has a laser radiation part.
	ISO 3864	Disassembly prohibition To indicate a risk of injury, such as electric shock, if the equipment is disassembled.
	---	Never look into the lens while the LED for lighting is on.
	IEC60417 No. 5266	Standby, partial standby To indicate that part of the equipment is in the ready status.
	ISO3864 IEC60417 No. 5057	Caution, movable parts To indicate that you must keep away from movable parts according to protection standards.

## Maximum radio-frequency power transmitted

		Models	
		H829B	WiT4-G0
WirelessHD Transmitter	60.16275-60.95725 GHz	-	32dBm e.i.r.p.
WirelessHD Receiver	60.16275-60.95725 GHz	27dBm e.i.r.p.	-





# Glossary

This section briefly explains the difficult terms that are not explained in context in the text of this guide. For details, refer to other commercially available publications.

Aspect Ratio	<p>The ratio between an image's length and its height. Screens with a horizontal:vertical ratio of 16:9, such as HDTV screens, are known as wide screens.</p> <p>SDTV and general computer displays have an aspect ratio of 4:3.</p>
HDCP	<p>HDCP is an abbreviation for High-bandwidth Digital Content Protection. It is used to prevent illegal copying and protect copyrights by encrypting digital signals sent over DVI and HDMI ports. Because the HDMI port on this projector supports HDCP, it can project digital images protected by HDCP technology. However, the projector may not be able to project images protected with updated or revised versions of HDCP encryption.</p>
HDMI™	<p>An abbreviation for High Definition Multimedia Interface. This is the standard by which HD images and multichannel audio signals are digitally transmitted.</p> <p>HDMI™ is a standard aimed at digital consumer electronics and computers. By not compressing the digital signal, the image can be transferred at the highest quality possible. It also provides an encryption function for the digital signal.</p>
HDTV	<p>An abbreviation for High-Definition Television. This refers to high-definition systems which satisfy the following conditions.</p> <ul style="list-style-type: none"> <li>• Vertical resolution of 720p or 1080i or greater (p = Progressive, i = Interlace)</li> <li>• Screen aspect of 16:9 Dolby Digital audio reception and playback (or output)</li> </ul>
Interlace	<p>Transmits information needed to create one screen by sending every other line, starting from the top of the image and working down to the bottom. Images are more likely to flicker because one frame is displayed every other line.</p>
MHL	<p>An abbreviation for Mobile High-definition Link, which is a standard high-definition interface that enables high-speed transfer of video signals on mobile devices.</p> <p>It is a standard targeting smartphones and tablets that transfers uncompressed digital signals without loss of quality and also enables simultaneous charging of such devices.</p>
Pairing	<p>Register devices in advance when connecting with Bluetooth devices to ensure mutual communication.</p>
SDTV	<p>An abbreviation for Standard Definition Television. This refers to standard television systems which do not satisfy the conditions for HDTV High-Definition Television.</p>
SVGA	<p>A screen size standard with a resolution of 800 (horizontal) x 600 (vertical) dots.</p>
SXGA	<p>A screen size standard with a resolution of 1,280 (horizontal) x 1,024 (vertical) dots.</p>
VGA	<p>A screen size standard with a resolution of 640 (horizontal) x 480 (vertical) dots.</p>
XGA	<p>A screen size standard with a resolution of 1,024 (horizontal) x 768 (vertical) dots.</p>
YCbCr	<p>In component image signals for SDTV, Y is the brightness, while Cb and Cr indicate the color difference.</p>
YPbPr	<p>In component image signals for HDTV, Y is the brightness, while Pb and Pr indicate the color difference.</p>



## General Notes

All rights reserved. No part of this publication may be reproduced, stored in a retrieval system, or transmitted in any form or by any means, electronic, mechanical, photocopying, recording, or otherwise, without the prior written permission of Seiko Epson Corporation. No patent liability is assumed with respect to the use of the information contained herein. Neither is any liability assumed for damages resulting from the use of the information contained herein.

Neither Seiko Epson Corporation nor its affiliates shall be liable to the purchaser of this product or third parties for damages, losses, costs, or expenses incurred by the purchaser or third parties as a result of: accident, misuse, or abuse of this product or unauthorized modifications, repairs, or alterations to this product, or (excluding the U.S.) failure to strictly comply with Seiko Epson Corporation's operating and maintenance instructions.

Seiko Epson Corporation shall not be liable against any damages or problems arising from the use of any options or any consumable products other than those designated as Original Epson Products or Epson Approved Products by Seiko Epson Corporation.

The contents of this guide may be changed or updated without further notice.

Illustrations in this guide and the actual projector may differ.

### Restriction of Use

When this product is used for applications requiring high reliability/safety such as transportation devices related to aviation, rail, marine, automotive etc.; disaster prevention devices; various safety devices etc; or functional/precision devices etc, you should use this product only after giving consideration to including fail-safes and redundancies into your design to maintain safety and total system reliability. Because this product was not intended for use in applications requiring extremely high reliability/safety such as aerospace equipment, main communication equipment, nuclear power control equipment, or medical equipment related to direct medical care etc, please make your own judgment on this product's suitability after a full evaluation.

## General Notice

EPSON and ELPLP are the trademarks or registered trademarks of Seiko Epson Corporation.

Mac and OS X are trademarks of Apple Inc.

Windows and the Windows logo are trademarks or registered trademarks of Microsoft Corporation in the United States and/or other countries.

HDMI and High-Definition Multimedia Interface are the trademarks or registered trademarks of HDMI Licensing LLC. 

PJLink trademark is a trademark applied for registration or is already registered in Japan, the United States of America and other countries and areas.

The Bluetooth® word mark and logo are registered trademarks of Bluetooth SIG, Inc., and the Seiko Epson Corporation uses these marks under license. Other trademarks or trade names are the property of their respective owners.

MHL, the MHL logo, and Mobile High-Definition Link are trademarks, registered trademarks, or service marks of MHL and LLC in the United States and/or other countries.

WPA™ and WPA2™ are registered trademarks of the Wi-Fi Alliance.

App Store is a service mark of Apple Inc.

Google Play is a trademark of Google Inc.

"QR Code" is a registered trademark of DENSO WAVE INCORPORATED.

CINEMASCOPE is a registered trademark of Twentieth Century Fox Film Corporation.

Qualcomm aptX is a product of Qualcomm Technologies International, Ltd.

Other product names used herein are also for identification purposes only and may be trademarks of their respective owners. Epson disclaims any and all rights in those marks.

©SEIKO EPSON CORPORATION 2016. All rights reserved.



### Indication of the manufacturer and the importer in accordance with requirements of directive 2011/65/EU (RoHS)

Manufacturer: SEIKO EPSON CORPORATION

Address: 3-5, Owa 3-chome, Suwa-shi, Nagano-ken 392-8502 Japan

Telephone: 81-266-52-3131

Importer: SEIKO EUROPE B.V.

Address: Azië building, Atlas Arena, Hoogoorddreef 5, 1101 BA Amsterdam Zuidoost The Netherlands

Telephone: 31-20-314-5000

- 3**
- 3D brightness ..... 88
  - 3D conversion ..... 52
  - 3D display ..... 88
  - 3D format ..... 88
  - 3D Glasses ..... 50
  - 3D Glasses charging port ..... 57
  - 3D images ..... 49
  - 3D settings ..... 88
  - 3D viewing notice ..... 88
- A**
- A/V mute ..... 36
  - Adjust lens shift ..... 7
  - Adjusting focus ..... 31
  - Adjusting RGB ..... 43
  - Adjusting the position of the image ..... 32
  - Adjusting the tilt ..... 32
  - Advanced ..... 87, 89
  - Air filter ..... 116
  - Air filter cover ..... 116
  - Air filter replacement period ..... 118
  - AMX Device Discovery ..... 99
  - Appearance ..... 136
  - Aspect ..... 38, 88
  - Audio ..... 89
  - Auto iris ..... 41, 87
  - Auto setup ..... 88
- B**
- Basic menu ..... 97
  - Bluetooth ..... 91
  - Brightness ..... 43, 86, 87
- C**
- CEC standards ..... 70
  - Channel ..... 97
  - Child lock ..... 91
  - Cleaning the 3D Glasses ..... 118
  - Cleaning the air filter ..... 116
  - Cleaning the lens ..... 118
  - Cleaning the main unit ..... 117
  - Color mode ..... 37, 86
  - Color saturation ..... 86
  - Color Temp. .... 86
  - Color Uniformity ..... 93, 125
  - Configuration menu ..... 85
  - Connected Device ..... 65
  - Connecting ..... 20
  - Connecting a computer ..... 20
  - Connecting Bluetooth devices ..... 22
  - Connecting external speakers ..... 24
  - Connecting smartphones or tablets ..... 20
  - Connecting to the Trigger Out port ..... 25
  - Connecting USB devices ..... 21
  - Connecting video equipment ..... 20
  - Connecting WirelessHD devices ..... 24
  - Connection Mode ..... 97
  - Contrast ..... 86
  - Control Panel ..... 8
  - Control panel ..... 7
  - Control panel lock ..... 91
  - Control4 SDDP ..... 99
  - Cool-down ..... 30
- D**
- Detail Enhancement ..... 87
  - Detail enhancement ..... 40
  - DHCP ..... 98
  - Direct power on ..... 94
  - Display ..... 93
  - Display Background ..... 93
  - Display LAN Info. .... 97
  - Display the QR Code ..... 96
  - Displaying the test pattern ..... 31
- E**
- EPSON Super White ..... 87
  - Error/Warning indicators ..... 101
  - Event ID ..... 114
  - Extended menu ..... 92
- F**
- Fine Line Adjust ..... 40, 87
  - Focus ..... 106
  - Focus adjustment ..... 31
  - Focus ring ..... 7, 31
  - Frame Interpolation ..... 86
  - Frame interpolation ..... 41
  - Full ..... 38
- G**
- Gain ..... 43, 87
  - Gamma ..... 45, 87
  - Gateway Address ..... 98
  - Gateway address ..... 98
- H**
- H/V-Keystone ..... 33, 89
  - HDMI 1 to 4 indicators ..... 57
  - HDMI Link ..... 90
  - HDMI link ..... 70

- |                          |        |
|--------------------------|--------|
| HDMI port .....          | 70     |
| HDMI Video Range .....   | 89     |
| High altitude mode ..... | 94     |
| Home Screen .....        | 92     |
| Home screen .....        | 29     |
| Hue .....                | 43, 87 |
- I**
- |                          |     |
|--------------------------|-----|
| Illumination .....       | 94  |
| Image .....              | 37  |
| Image Enhancement .....  | 87  |
| Image enhancement .....  | 40  |
| Image menu .....         | 86  |
| Image Processing .....   | 89  |
| Image processing .....   | 42  |
| Images .....             | 72  |
| Indicators .....         | 101 |
| Info menu .....          | 99  |
| Inverse 3D Glasses ..... | 88  |
| Inverse audio .....      | 89  |
| IP Address .....         | 98  |
| IP address .....         | 98  |
| IP Address Display ..... | 98  |
| IP address display ..... | 98  |
| IP Settings .....        | 98  |
- K**
- |                           |    |
|---------------------------|----|
| Keystone .....            | 89 |
| Keystone distortion ..... | 33 |
- L**
- |                               |        |
|-------------------------------|--------|
| Lamp cover .....              | 7, 120 |
| Lamp cover fixing screw ..... | 120    |
| Lamp replacement period ..... | 118    |
| LAN port .....                | 25     |
| Language .....                | 94     |
| Lens shift dial .....         | 32     |
| Link indicator .....          | 57     |
| Load memory .....             | 47     |
| Lock setting .....            | 91     |
- M**
- |                            |    |
|----------------------------|----|
| Memory .....               | 92 |
| Memory function .....      | 47 |
| Menu .....                 | 85 |
| Messages .....             | 93 |
| Model Name .....           | 93 |
| MPEG Noise Reduction ..... | 87 |
| MPEG noise reduction ..... | 40 |
| Mute .....                 | 36 |
- N**
- |                           |     |
|---------------------------|-----|
| Network information ..... | 96  |
| Network menu .....        | 95  |
| Noise .....               | 106 |
| Noise Reduction .....     | 87  |
| Noise reduction .....     | 40  |
- O**
- |                            |        |
|----------------------------|--------|
| Offset .....               | 43, 87 |
| On/Standby indicator ..... | 57     |
| Operating range .....      | 27     |
| Operating time .....       | 121    |
| Operation .....            | 94     |
| Others menu .....          | 99     |
| Overscan .....             | 89     |
- P**
- |                          |             |
|--------------------------|-------------|
| Pairing .....            | 51          |
| Panel Alignment .....    | 93, 95, 123 |
| Passphrase .....         | 98          |
| Picture in Picture ..... | 74          |
| PJLink .....             | 127         |
| PJLink Password .....    | 97          |
| Position .....           | 88          |
| Power .....              | 30          |
| Power consumption .....  | 87          |
| Power supply .....       | 28          |
| Progressive .....        | 87          |
| Projection .....         | 93          |
| Projection size .....    | 31          |
| Projector Info .....     | 99          |
| Projector name .....     | 97          |
- Q**
- |                    |        |
|--------------------|--------|
| Quick Corner ..... | 34, 89 |
|--------------------|--------|
- R**
- |                                           |                |
|-------------------------------------------|----------------|
| Remote control .....                      | 10, 27         |
| Remote Password .....                     | 97             |
| Replacement periods for consumables ..... | 118            |
| Replacement time .....                    | 118            |
| Replacing consumables .....               | 119            |
| Replacing the air filter .....            | 119            |
| Replacing the lamp .....                  | 120            |
| Reset .....                               | 87, 89, 92, 95 |
| Reset all config .....                    | 100            |
| Reset lamp hours .....                    | 100, 121       |
| Reset memory .....                        | 100            |
| Reset menu .....                          | 99, 100        |
| RGBCMY .....                              | 43, 87         |

**S**

Saturation .....	43, 87
Save memory .....	47
Search Access Point .....	97
Security .....	98
Security menu .....	98
Settings menu .....	89
Sharpness .....	39, 86
Signal menu .....	88
Sleep mode .....	94
Slideshow .....	72
Soft Focus Detail .....	40, 87
Soft Keyboard .....	96
Source .....	28
Specifications .....	132
SSID .....	97
SSID Display .....	98
Standby Mode .....	94
Startup Screen .....	93
Sub menu .....	85
Subnet Mask .....	98
Subnet mask .....	98
Super-resolution .....	40, 87
Supported resolutions .....	129
Sync. ....	88

**T**

terminal cover .....	26
Tint .....	86
Top menu .....	85
Tracking .....	88
Transmission range .....	66
TV indicator .....	57

**U**

USB .....	72
User button .....	91

**V**

Version .....	99
Video Reception .....	65
Volume .....	35, 89

**W**

WiHD indicator .....	57
Wired LAN menu .....	98
Wireless LAN menu .....	97
Wireless LAN Power .....	95
Wireless LAN unit .....	26
WirelessHD .....	56, 90

**Z**

Zoom .....	38
Zoom adjustment .....	31
Zoom ring .....	7, 31